

A. L. Winne & Co. respectfully refer, by permission, to the following parties having their Heating Apparatus.

Wm. Pross,	Chicago,	Washington Smith,	Chicago
E. B. McCagg,		Rev. Wm. A. Bartlett,	
S. M. Nickerson,		O. F. Fuller,	
W. F. Coolbaugh,		J. W. Odell,	
Hiram Wheeler,		Land Department, I. C. E. R.	
E. G. Hall,		Chamber of Commerce,	
Perry H. Smith,		Hartford Insurance Co.,	
Gurdon S. Hubbard,		Chicago Republican,	
James L. Stark,		Grosby's Opera House,	
Wm. D. Orden,		Honore Block,	
Lyman Blair,		Convent and Academy of St. Fran-	
George M. Kimbark,		cis Xavier,	
Peter Schuttler,		First Baptist Church,	
Geo. Sturges,		Riverside Hotel,	Riverside, Ill.
Edward Burling,		H. G. Powers,	Evansville
James P. Dutton,		H. B. Hurd,	
S. D. Kimbark,		R. S. King,	
C. B. Goodyear,		Edwin Haskins,	
E. L. Jansen,		E. R. Paul,	
E. L. Jillett,		J. H. Redzie,	
J. B. Lyon,		T. A. Cosgrove,	
Wm. V. Kay,		Female Seminary,	Lake Forest, Ill.
F. B. Gardner,		J. W. Shaffer,	Freeport,
S. J. Surdam,		O. B. Bidwell,	
Geo. H. Wheeler,		R. Emerson,	Rockford,
O. L. Wheelock,		Universalist Church,	Peoria,
Geo. R. Whitman,		Washington Cocker,	
S. B. Williams,		E. D. Harding,	Knoxville,
Alfred Cowles,		County House,	Springfield,
N. S. Pouton,		C. Ridgely,	
A. C. Badger,		P. O. & Custom House,	
Frederick Tuttle,		Inst. for Ed. of Blind,	Indianapolis
E. H. Shekton,		Citizen's Nat'l Bank,	
G. B. Larrabee,		2nd Presbyterian Church,	
L. B. Boomer,		J. H. Baldwin,	
S. W. Allecton,		Frank M. Churchman,	
H. H. Honore,		J. W. Copeland,	
S. C. Griggs,		Fletcher's Bank,	
Andrew Brown,		High School,	Lafayette, Ind.
H. E. Seelye,		Eastern School,	
E. S. Isham,		1st National Bank,	
J. Goodwin, Jr.,		Martin L. Peirce,	
S. B. Cobb,		Henry Taylor,	
P. T. Turnley,		George Greene,	C. Rapids, Iowa
H. O. Stone,		L. W. Olds,	Muscatine,
Thos. Hoyne,		Mark Ranney, M.D.,	Mt. Pleasant,
Peter Page,		E. W. Brooks,	Burlington,
Wm. Blair,		High School,	Des Moines,
W. A. Butlers,		P. O. & Custom House,	
J. M. W. Jones,		German Lubkn School,	St. Louis, Mo.
Geo. W. Gage,		Nat. Bank State of Missouri,	
Cyrus Bentley,		Evangelical Lutheran Church,	
Carter H. Harrison,		Provident Savings Institution,	
John N. Gage,		R. W. Oliphant, M. D.	
C. B. Nelson,		Truett Polk,	
Chas. L. Wilson,		John H. Beach,	
S. L. Keith,		George Rogers,	
Allan Pinkerton,		J. H. Brittain,	
Harry Fox,		D. C. Jaccard & Co., Jewelers,	
A. H. Miller,		Geo. E. Leighton,	
John Forsythe,		J. G. Chapman,	

We have the Reference Lists of firms engaged in the introduction of the Union Steam and Water-Heating Apparatus in the Eastern Cities, in which may be found most of the prominent Public Buildings, Asylums and Schools.

ESTABLISHED AT  
St. Louis, 1834.  
Louisville, 1833.

CONFIDENCE

ESTABLISHED IN  
Chicago, 1861.  
N. Orleans, 1863.

# EDWARDS' DIRECTORIES.

The Standard and Official Directories of the South and West.

*From the Chicago Evening Journal.*

As Edward's Directories have been pronounced the best EVER PUBLISHED IN CHICAGO, and as they have been THOROUGHLY TESTED BY ALL CLASSES OF CITIZENS, we can fully rely upon the forthcoming work as being in every particular correct and reliable.

*Resolution of the City Council of Indianapolis.*

BE IT RESOLVED, That the CITY COUNCIL of Indianapolis, feeling the want, and knowing the value of such a work to their fellow-citizens, and appreciating the enterprise of Mr. Edwards in issuing the Indianapolis Directory for the last few years in a manner creditable to the city and himself, and that we recommend our citizens to give their support to Edwards' Directory, thus securing the annual publication of a standard work.

JOHN CAVEN, Mayor.

CYRUS S. BUTTERFIELD, City Clerk.

*From the Chicago Daily Tribune.*

Edwards' Directory combines all the qualities needed in a work of this kind, and has the entire confidence of the business men of all classes. The highest testimonials have been bestowed upon it. It has been pronounced "unsurpassed for beauty and correctness;" "THE STANDARD BOOK OF THE CITY;" "an indispensable requisite to every business office;" "highly appreciated by the business community and travelers generally;" "an institution in the West, and its annual visit always welcome," &c., &c.

*From the St. Louis Daily Times.*

Mr. Edwards is emphatically a pioneer in this branch of business, and is a faithful representative of St. Louis enterprise. He commenced the publication of Directories for this city many years ago, after all had failed in previous attempts, and has continued the issue under all circumstances every year since. Not long after his advent here, he commenced the publication of Directories for Louisville, Indianapolis and Milwaukee. Next he tackled Chicago, where he had to encounter a strong opposition for three years, finally coming out victorious. He also publishes Directories for Memphis, Mobile and New Orleans. As a Directory publisher, "no pent-up Utica contracts his powers," but wherever he sees a point, in common parlance, he "makes for it," and where others would be months in issuing a like work, he accomplishes the task in the same number of weeks, complete and reliable. Our Merchants' Exchange have taken the right view of the value of a City Directory to our people, as well as to strangers, and have passed the following complimentary resolution in regard to it:

*Merchants' Exchange Resolution.*

WHEREAS, THE MERCHANTS, MANUFACTURERS AND BUSINESS MEN of St. Louis regard the publication of an annual Directory of our city a great convenience and a business necessity, and that our fellow citizen, Mr. Richard Edwards, has for many years issued such a work as has shown from time to time our growth and the greatness of St. Louis; be it

RESOLVED, That the Union Merchants' Exchange of St. Louis appreciate the enterprise and public spirit of Mr. Edwards, in permanently establishing a standard annual Directory of the city, and that we recommend our fellow citizens to give him such annual encouragement, by subscription and otherwise, as will enable him to issue such a Directory as will be justly entitled the Model Directory of the West, and that the Secretary be instructed to forward a copy of the Directory, with the compliments of the President and Directors of the Exchange, to the various Exchange Rooms and Board of Trade Rooms of large cities of the country.

GEO. H. MORGAN, Secretary.

Hundreds of such notices and resolutions have been given to EDWARD'S DIRECTORIES in the various Cities of the South and West.

# MISSISSIPPI & TENNESSEE Rail Road.

Only Direct Route to

## New Orleans VICKSBURG, AND ALL POINTS SOUTH.

Trains leave Daily from the Depot, foot of Main St.

### DIRECT AND SURE CONNECTIONS!

### Baggage Checked Through.

Through Bills of Lading given on Freight for New Orleans. Procure Through Tickets, Through Bills of Lading, and information at

## 237 <sup>1</sup>/<sub>2</sub> MAIN STREET,

OR AT THE DEPOT

## MEMPHIS, TENNESSEE.

**C. P. OAKLEY,**      **A. S. LIVERMORE,**  
Gen'l Trans. and Ticket Agt.      Gen'l Superintendent.

## CHICAGO, ALTON & ST. LOUIS RAIL ROAD.

SHORTEST, QUICKEST and SAFEST ROUTE to all Parts of the SOUTH & SOUTH-WEST  
Direct and Immediate Connections made at St. LOUIS for  
Kansas City, Leavenworth, Atchison, St. Jo., Lawrence, Topeka, Memphis, N. Orleans, and all Points South & South West.

Trains arrive at and leave Chicago as follows:

Express Mail.....	+ 8:10 a. m.	+ 8:00 p. m.
Joliet Accommodation.....	+ 4:40 p. m.	+ 9:40 a. m.
Night Express.....	+ 6:00 p. m.	+ 6:00 a. m.
Lightning Express.....	+ 9:50 p. m.	+ 8:30 a. m.

+ Except Sundays. † Runs through to St. Louis every night. ‡ Saturdays and Sundays excepted. \* Except Monday.

### PULLMAN'S PALACE SLEEPING CARS ON NIGHT TRAINS.

And Dining Coaches on all Through Trains.

Baggage Checked Through.

THROUGH TICKETS can be had at Company's Office, No. 45 Dearborn St., Chicago, or at Depot, cor. W. Madison and Canal Sts., and at all principal Ticket Offices in the United States and Canada. Rates of Fare and Freights as low as by any other route.

**A. NEWMAN,**  
Gen'l Passenger Ag't.

**J. C. McMULLIN,**  
Gen'l Superintendent.

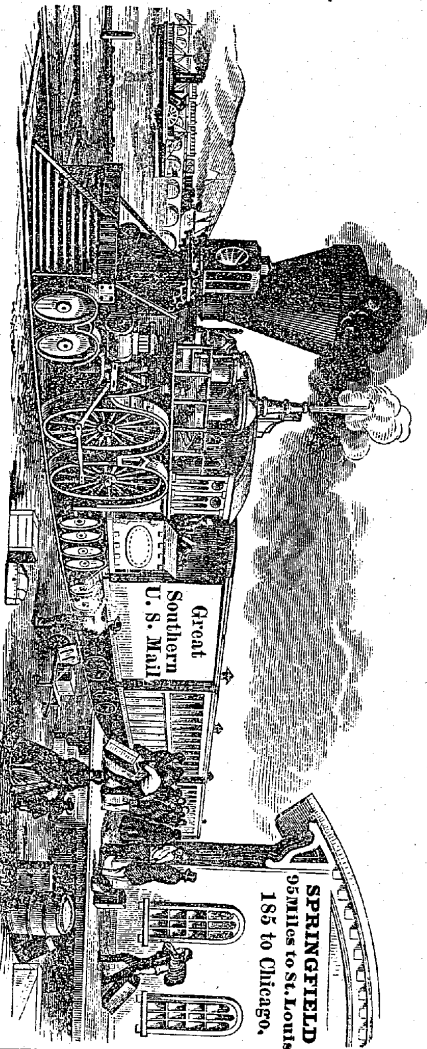

IS THE ONLY ROAD FROM CHICAGO TO ST. LOUIS VIA ALTON, SPRINGFIELD, BLOOMINGTON AND JOLIET,  
WITHOUT CHANGE OF CARS.



## BOGUS DIRECTORIES.

The following notice from the *Louisville Courier* will apply to People of this City, as they have been shamefully swindled by Directory Adventurers and Bogus Publishers:

"It appears to us that our community ought to be satisfied with the experiments which have been made in our midst, in the way of making Directories. For some years past, we have had Tom, Dick, and Harry who supposed themselves capable of compiling and publishing a City Directory. Each of these adventurers (for we can call them nothing else) made great and sweeping promises, and assured our business community that their works should surpass all others; and further, that their valuable (?) book would be continued from year to year. Among the number of those who have attempted to give our citizens a Directory, remember the names of WHITE, HURD, BURROUGHS, TANNER, CAMPBELL, RICHARDSON, WILLIAMSON, EDWARDS, and a host of others. Every one of these men, with the exception of Mr. EDWARDS, have utterly and totally failed in giving satisfaction to the community, and their great display of ability, and the advantages offered them. In 1866 Mr. Edwards was solicited by over ONE HUNDRED OF OUR BUSINESS CITIZENS to issue a Louisville Directory, with a guarantee on their part that they would sustain him in the undertaking. He did so, under many disadvantages, as the canvass was commenced and completed during the excitement consequent upon the war and the drafting of men. In 1866, Mr. Edwards, as promised, again issued his Directory, in the face of strong opposition made by Mr. Williamson, and the annoyance which our merchants were then subjected to is well remembered by all. EDWARDS' DIRECTORY gave ENTIRE and PERFECT SATISFACTION. It was the BEST EVER published in this city, and all that could have been desired.

"The truth is that the publishing of Directories, is a trade, so speak, and a business by itself. It requires large experience, extraordinary patience, business tact and capital. All of these, the firm of Edwards & Co., possess. They publish Directories for all of our principal Western cities, and their thorough knowledge of their profession is a guaranty that all they promise will be promptly and well done. Therefore we caution our people against giving aid or countenance to any of all Directory adventurers, and ask their support to the regular, reliable Louisville Directory, about to be issued by Edwards & Co. By doing this, they will secure a work that can be depended upon, and one every way worthy of our city."

## Great Central Route.

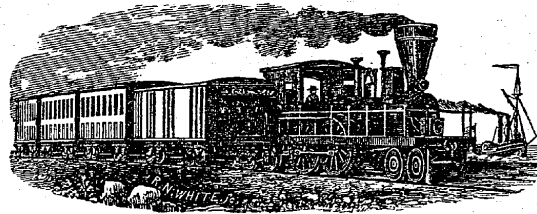

# MICHIGAN CENTRAL AND Great Western Railways

CHICAGO to NIAGARA FALLS 513 Miles

4 Express trains each way daily, making connections at Chicago and Suspension Bridge, with all important Lines of travel.

The Passenger equipments of this line are unsurpassed. Every modern improvement for the Safety and Comfort of the traveler are in use.

**PULLMAN'S**  
Celebrated Drawing Room, Hotel & Sleeping Cars

Are run upon all Night Trains.

This line gives superior accommodation to Emigrants who desire to settle in the Great West. Special Emigrant trains are run daily, and good comfortable cars, supplied with every convenience are furnished.

Through Tickets via this favorite Route can be purchased at all Ticket offices in the country.

IN CHICAGO,	- - -	at 93 Lake Street.
IN NEW YORK,	- - -	at 349 Broadway.
IN BOSTON,	- - -	at 69 Washington St.

### OFFICERS,

H. E. SARGENT, Gen'l Supt. M. C. R. R.  
W. K. MUIR, Gen'l Supt. Gr. W. Ry.  
CHAS. E. NOBLE, Gen'l East. Agt., 349 Broadway, N. Y.  
HENRY C. WENTWORTH, Gen'l Western Agent,  
93 Lake Street, Chicago.

1870. GREAT CENTRAL ROUTE. 1870.

## Blue Line

ORGANIZED JANUARY 1, 1887.

OWNED AND OPERATED BY

Michigan Central, Illinois Central, Chicago, Burlington & Quincy, Chicago & Alton, Great Western (of Canada), New York Central, Hudson River, Boston & Albany, and Providence and Worcester Rail Roads.

### THE "BLUE LINE"

Is the only route that offers to shippers of freight the advantages of an unbroken gauge through from Chicago to the Seaboard and to all Interior Points on the line of Eastern Connections beyond Suspension Bridge and Buffalo. All through Freights is then transported between the most distant points of the roads in interest.

### WITHOUT CHANGE of CARS!

The immense freight equipment of all the roads in interest is employed as occasion requires, for the through service of this Line, and has of late been largely increased. This Line is now prepared to extend facilities for the transit and delivery of all kinds of freight in Quicker Time and in Better Order than ever before.

### THE BLUE LINE CARS

Are of solid, uniform build, thus largely lessening the chances of delay from the use of a mixed construction, and the consequent difficulty of repairs, while remote from their own roads. The Blue Line is operated by the railroad companies who own it, without the intervention of intermediate parties between the Roads or Line and the public.

Trains run through with regularity IN FOUR OR FIVE DAYS to and from New York and Boston. Especial care given to the Safe and Quick Transport of Property Liable to Breakages or Injury, and to all Perishable Freight.

Claims for overcharges, loss or damage, promptly settled upon their merits. Be particular and direct all shipments to be marked consigned via

### "BLUE LINE."

FREIGHT CONTRACTS given at the offices of the company in Chicago, New York and Boston, etc.

**J. D. HAYES, General Manager, Detroit.**

THOS. HOOPS, M. C. R. R.	Chicago.	P. K. RANDALL, 69 Washington st. Boston.
A. WALLINGFORD, Tremont Blk.	"	P. F. GAY, B. & A. Depot Boston.
N. A. SKINNER, M. C. R. R.	"	W. BLISS, B. & A. R. R. Springfield, Mass.
W. W. STREET, M. C. R. R.	"	S. DRULLARD, N. Y. C. Depot, Albany.
F. A. HOWE, M. C. R. R.	"	I. MULFORD, H. R. R. New York.
JNO. CRAMPTON, M. C. R. R. Dep't Detroit.	"	GEO. E. JARVIS, 349 Broadway, New York.
T. J. CRAFT, " " "	"	S. JOHNSON, Ill. Central R. R. Cairo.
L. P. KNIGHT, " " "	"	S. SMITH, C. & St. Louis R.R., St. Louis, Mo.
T. BUTTERS, G. W. R. Depot, Susp. Bridge.	"	N. D. MUNSON, C. B. & Q., Quincy, Ill.
J. S. WOOD, 345 Main st., Buffalo.	"	H. KENDALL, Leavenworth, Kansas.
		E. R. HORTON, St. Joseph, Mo.

# NEW ORLEANS JACKSON

AND

## GREAT NORTHERN RAIL ROAD.

### Quickest Line of Travel

From

## NEW ORLEANS

TO ALL THE

Great COMMERCIAL CITIES and RESORTS of PLEASURE

IN THE

## UNITED STATES AND CANADA.

The greatest variety of routes to the same place is presented to the choice of the traveler, affording him the opportunity of interspersing his journey with *Water Travel*, or selecting the short and swift

### ALL RAIL LINE.

### SLEEPING CARS ON ALL NIGHT TRAINS.

Trains leave Depot at foot of Calliope Street,  
DAILY at 7 A. M. and 5 P. M.

Connecting at Jackson with Southern Mississippi Railroad for Vicksburg, Montgomery, etc., and at Canton with Mississippi Central Railroad for all points North and East.

THROUGH TICKET OFFICE, Cor. Camp and Common Streets,  
Under City Hotel.

Passengers can procure Tickets at the Depot previous to leaving of the Cars.

THE  
**Iron Mountain**  
RAILROAD

IS THE  
**SHORT LINE**  
BETWEEN  
**COLUMBUS, KY. AND ST. LOUIS.**



This new road has been recently opened to the public, and offers superior inducements both to travelers and shippers. The road bed is in fine order and the iron is all new and laid in the best possible manner.

Passengers taking this route save time and one change of cars, avoid 20 miles of dangerous river transfer, and are delivered at any hotel or depot in St. Louis FREE of extra charge.

**2** THROUGH PASSENGER TRAINS  
EACH WAY DAILY.

**SLEEPING CARS ON ALL NIGHT TRAINS.**

It is proposed, and the Company is preparing, to run through cars from New Orleans, Mobile and Memphis to St. Louis without change or breaking bulk.

Ask for Tickets via Iron Mountain Railroad.

Ticket Office, St. Louis under **SOUTHERN HOTEL.**

In New Orleans, under **CITY HOTEL.**

In Mobile, under **BATTLE HOUSE.**

**W. R. ALLEN,** **J. H. MORLEY,** **SETH FRINK,**  
G. P. & T. Agt. Gen'l Supt. G. F. A. St. Louis.

**EASTERN DEPARTMENT**

1870.

**BUSINESS DIRECTORY.**

# Dennison's Tags!

## FOR MARKING EVERY DESCRIPTION OF MERCHANDISE

SUCH AS

HARDWARE, DRY GOODS

MACHINERY,

Agricultural Implements,

GUM LABELS,



FANCY TICKETS.

CLOTHING, STOVES, &amp;C.

FURNITURE,

FANCY GOODS, JEWELRY

— ALSO —

## DENNISON'S PATENT

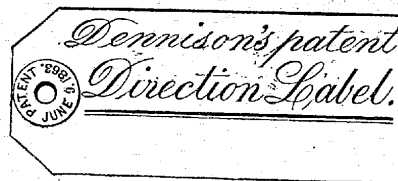

## SHIPPING TAGS!

Made from Dennison's Tough, Cheap Stock, and warranted superior to all others. For sale by

**DENNISON & CO.,**  
BOSTON, NEW YORK, PHILADELPHIA, CHICAGO

— AND BY —

PRINTERS AND STATIONERS GENERALLY.

# BUSINESS DIRECTORY

OF THE  
PATRONS OF THE WORK,

EMBRACING

Their Names and Address, alphabetically arranged, according to their respective trades, business and professions.

AGR

3

BOO

### Agricultural Implements.

#### PARKER & GANNETT,

Agricultural warehouse and seed stores, fertilizers, etc. 49 N. Market and 46 Merchants' row, Boston. Whittemore, Belcher & Co. 34 Merchant's row, Boston

#### Air Pumps.

#### POTTLE BROS.

71 Sudbury, Boston

#### Ale Pumps and Soda Water Apparatus.

Puffer A. D. 48 Portland, Boston

#### Artists' Colors and Materials.

#### FROST & ADAMS,

33 and 35 Cornhill, Boston, Springer L. R. 351 Washington, Boston

#### Axes.

Amoskeag Axe Co. 70 Kilby, Boston

#### DOUGLAS AXE MANUFACTURING CO. manufacture Hunt's and Sharp's axes and other Edge tools, 215 Federal, Boston

#### Axles and Springs.

#### BRIDGEPORT SPRING CO.

W. H. Rockwell, sec. Edwin Banks, treas. Bridgeport, Conn. (See adv't.) Linden Iron and Steel Co. 82 Federal, Boston

#### Bags and Bagging.

Chase H. & L. 233 State, Boston Jewell I. B. 91 Haverhill, Boston Stearns A. P. 52 Brattle, Boston

#### Band Saw Machines.

#### WELCH, HARRISON & CO.

644 Federal, Boston. (See adv't.)

#### Bankers and Brokers.

Bangs E. D. & G. W. & Co. 88 State, Boston Day R. L. & Cobb, 31 Kilby and 16 Lindell, Boston

### Baskets and Willow Ware.

#### ZINN CHARLES & CO.

496 Broadway and 72, 74 and 76 Walker, New York

#### Belting.

Gage D. T. 118 Market, Philadelphia

#### Bitters.

Langley J. H. & Co. 207 Fulton, New York

#### Blacking and Dressings.

Bassett & Whitcomb, 7 Bath, Boston

#### BROWN B. F. & CO.

Manufacturers of blackings and dressings for boots and shoes. Office, 36 Pearl. Factory, 133 and 135 Fulton, Boston

#### Bobbins and Spools.

Watson Edward F. Mechanic's Mills, Lowell, Mass.

#### Boiler Tubes.

#### MORRIS, TASKER & CO.

209 S. 3d, Philadelphia; and 15 Gold, New York

#### Book Binders' Machinery.

#### RIEHL M.

1505 Willow, Philadelphia. (See adv't.)

#### Boot Manufacturers.

Smith Marshall, Foster, cor. Cypress, Worcester Mass.

#### Boot and Shoe Findings.

#### BUTTERFIELD WILLIAM,

dealer in wax thread sewing machines, channel cement and McKay machine needles, shoe findings machine twist and Marshall's linen thread, 6 Mray, New York

#### KRIEG J. K. & CO.

44 Warren, New York, (See adv't.)

# BUERK'S Watchman's Time Detector.

## THIS WATCH-CLOCK

Was introduced to the public in almost every section of the United States and Canada, about five years ago, and it has proved itself to be

## THE BEST INVENTION IN THE WORLD

For testing the faithfulness of Watchmen. Since its introduction, the Proprietor has improved on some parts, and corrected deficiencies which have been suggested by using it, and he has now a perfect check upon the Watchman. With other clocks, a regular routine has to be followed; but with this, a watchman can be ordered to visit any particular place as often as required, without being compelled to go to places where it is not necessary to visit as often.

The instrument is complete in itself, portable, and as reliable as the best lever watch. It is not so likely to become disarranged in its work as a good watch, because its parts are stronger. But when it needs cleaning, any common watchmaker can adjust it, its mechanism being simple.

It requires no fixtures or wires communicating from room to room, as is the case with ordinary Watch-Clocks; a small, inexpensive stationary key is alone required at each station.

Its use is not restricted to a single building, and places can be guarded that it would be impossible to guard with any other instrument, such as Railroad Tunnels, Bridges, Yards, Shops, etc.

The instrument will, in all cases, be warranted perfect and satisfactory. Its price is invariably SEVENTY-FIVE DOLLARS, Cash on delivery, including as many keys as are requisite, not exceeding twelve. This Watch-Clock is

**Sold At A Less Price than Any Other in the Market.**

**THE DETECTOR** is used extensively by Large Manufacturing Establishments and Railroad Companies in the United States, from whom numerous testimonials have been received.

Parties purchasing these Clocks should test them sufficiently in the Counting-room or Office, as they will not be taken back after having been injured by the watchman through carelessness. All communications promptly attended to. Address:

**J. E. BUERK, Proprietor.**

**Post Office Box 1057, 47 Congress Street, BOSTON.**

N. B.—It is very essential to carry the Clock secure, taking care that it is not brought in contact with any hard substance, and thereby broken. I have on hand pouches with straps to go over the shoulder and around the body, which I will send with the Clock, if ordered. Price, \$2.50.

This Detector is covered with two United States Patents. Parties using or selling these instruments without authority from me, will be dealt with according to law.

# BUERK'S WATCHMAN'S TIME DETECTOR.

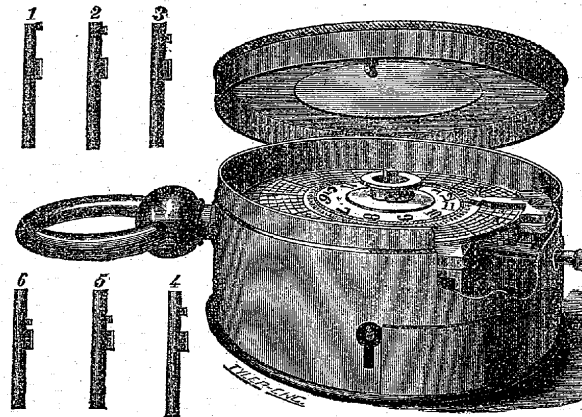

All large corporations or manufacturing concerns employ watchmen, who look to the safety of the several buildings, and are expected to be vigilant in guarding the interests committed to their charge. Property of immense value is thus at the mercy, so to speak, of one man; for if he is neglectful of his duty, he is not only dishonest, but jeopardizes the daily bread of numbers of persons who may have funds invested in the concern.

To hire one watchman to look after the other would not be a very wise proceeding; for, by collusion, they might set at naught all such precautions. Recourse is therefore had to machinery—silent, insensate wheels and springs. By the judicious combination of these, tales can be told which result in the dismissal of the untrustworthy servant, or his retention and reward if found worthy.

The above engraving is a view of a Time Detector, which is carried about by the watchman to all the different stations to be guarded. At each station is a key, securely fastened to prevent his taking it with him. The watchman goes from station to station, takes the key fastened there, inserts it into the clock, gives it one turn, and goes on to the next, or to any other station, for he is not bound to go in regular order. By this it follows that a perfect record will be kept of each operation.

The broken-out portion of the watch shows the mechanism which operates the pin which pricks the paper. At A, there is a number of sliding bars, which connect with the pricking points, so that, by turning round the key, the ward on it strikes a certain bar, and penetrates the dial paper B. By that act, a small hole is made in the paper, which tells what time the man appeared at each station, how often he came there, how long he stopped, how long it took him to go from one to another, whether he went in regular order or not, in short, it gives a complete record of his night's work.

The small figures are views of different keys. A flange on the side of the key prevents it from being turned, unless it is inserted quite into its place; so that the key used for one station cannot be used to make a mark for a key at another, nor indeed, can any key except a perfect duplicate, be made to do it. Any attempt on the part of the watchman to evade his duty by counterfeiting keys, may be effectually baffled by occasionally changing keys from one station to another. An indefinite number of stations can be served.

The watch is wound, set and closed each evening, by the proprietor or superintendent, and the box locked with a key which he keeps, so that the register within is unseen by, and out of reach of, the watchman who carries it. In the morning, when the Detector is returned to the superintendent, the graduated disk of paper may be removed from its position, and filed like a telegraph despatch, as a permanent record, while a new disk is applied for succeeding records.

## BOO

**Boot and Shoe Machinery.**

Butterfield William, 26 Pearl, Boston

**KRIEG J. K. & CO.**

dealers in boot and shoe machinery and findings, Union wax thread and Howe sewing machines constantly on hand; Krieg's patent hoeling jack, Plumber's patent trimming jack, duplicate parts for McKay's sewing machine, all kinds of sewing machine needles, button hooks, sandpaper, in sheets and rolls; machine wax, liquid and hard; machine oil, channel cement, ink, blacking, cotton waste, nails, tacks, etc. Andover thread for machine and hand work; a full assortment of boot and shoe kit, etc. Agents for the American solid emery wheels and hones, 44 Warren, New York. Particular attention paid to repairing shoe machinery.

Pease L. J. &amp; Co. 7 Cypress, Worcester, Mass.

**Boot and Shoe Manufacturing Goods.****BROOKS & YOUNG,**

58 Pearl, Boston

**CRAGIN, PAGE & CO.**

Kilby, cor. Milk, Boston

**HAVEN & WRIGHT,**

also dealers in machine thread, 26 Pearl, Boston

**ROSS, PEARCE & CO.**

sewing machine threads, boot and gaiter webs, elastic goring, shoe ducks, etc. 58 and 60 Milk, Boston

**Boot and Shoe Patterns.****AMERICAN STANDARD PAT-**

TERN CO. manufacture brass-edge boot and shoe patterns, and patterns for all kinds of goods. Dies, lasts and zinc patterns made to order, 1 Pearl, Boston

**Boot and Shoe Studs.****BOSTON SHOE STUD AND**

BUTTON CO. 2 Pearl, Boston. (See adv't.)

**Boot and Shoe Warehouses.**

Belcher A. &amp; G. W. 94 Pearl, Boston

**BLANCHARD CHARLES,**

wholesale manufacturer of ladies', misses' and childrens' calf boots and shoes, 118 Merrimack, Haverhill, Mass.

**CHASE, MERRITT & BLAN-**

CHARD, 20 and 22 Pearl, Boston

**FAY & STONE,**

94 Pearl, Boston

**GALE WILLIAM H.**

manufacturer of ladies' fine boots and shoes, 87 Market, Lynn, Mass.

**Holton Frederic & Co. 9 Pearl, Boston****LANE JENKINS & SONS,**

manufacturers and wholesale dealers in boots and shoes, 61 and 63 Pearl, Boston

**Long William N. 128 Merrimack, Haverhill, Mass.****MARTIN GEORGE B. & BRYANT,**

13 and 15 Pearl, Boston

**POTTER & JAQUES,**

ladies', misses' and childrens' fine boots and shoes, 200 Merrimack, Haverhill, Mass.

Shaw T. V. &amp; W. A. 34 Pearl, Boston

Wood Amos L. &amp; Co. 56 Pearl, Boston

## BUR

**Branding Irons.****PENNEY FRANK L.**

8 Dock Square, Boston

**Brass Cock Manufacturers.****JONES J. & H. & CO.**

dealers in plumbers' supplies and importers of plumbers' earthenware, 16 W. 4th, New York

**Brass Finishers.****MEAD & ADDY,**

2 Bath, Boston

**Brass Manufacturers.**

Manhattan Brass and Manufacturing Co. Works, 27 1/2, cor. 1st av. Office, 40 John, New York

**Brick Machinery and Tools.****CARNELL F. L. & D. R.**

1244 Germantown av. Philadelphia

**Bronze Powders.**

Brandels L. &amp; Co. sole manufacturers in the United States, of bronze powders, gold, silver and metal leaf. Office, 87 Fulton, New York. Factory, 44 Fulton, Brooklyn, New York

**Broker, Iron.****CUTLER E. P.**

15 Kilby, Boston

**Brush Manufacturers.****CLINTON E. & CO.**

manufacturers and importers of brushes, 908 Chestnut, Philadelphia

**JOHN K. HOPPEL,****Brush Manufacturer**

AND IMPORTER,

329 Pearl Street

[Harper's Bldg.]

FRANKLIN SQ.

NEW YORK

MACHINE BRUSHES

MADE TO

ORDER.



A SUPERIOR QUALITY OF

**PAINT BRUSHES**

CONSTANTLY ON HAND.

**ALSO GIN BRISTLES.**

Whiting John L. 8 Blackstone, Boston

**Burning Brands.****PENNEY FRANK L.**

8 Dock Square, Boston

# DEGENER & WEILER'S 'Liberty' Card and Job Presses.

No. 23 Chambers Street,

Corner of Centre Street,

NEW YORK.

1st Premium World's Fair, London, 1862, and Paris Exposition, 1867.

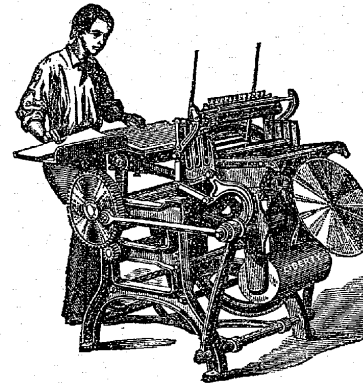

expedite the building of the same—which enables us to duplicate any part of our presses, in case of accidental breakage.

**THE ADVANTAGES OF THIS PRESS OVER ALL OTHERS.**

Simplicity of construction, durability and strength of build—in which the best materials are used. Ease in running, the ability to print a form as large as can be locked in the chase, convenience of "making ready," adjusting or cleaning, facility of correcting a form without removing it from the bed, as it can be brought into nearly a horizontal position. Three rollers may be used for inking a form. These are held in stationary fixtures, without springs, and are readily removed by the operator, without soiling his fingers.

Size No. 2 has a special arrangement for printing cards, by means of which they are dropped into a box below, or may, at will, be retained on the platen for examination.

While the impression is being taken, the form, the platen and the ink distributing table are brought before the eye of the operator and the inking rollers are always in sight. The face of the bed never moves beyond the vertical line, therefore no type can drop out. The fly-wheel may run either way without altering the working of the press. The speed is according to the ability of the operator, from 1,000 to 2,500 per hour.

**SIZES AND PRICES OF THE "LIBERTY" PRESS.**

No. 2.—Card and Circular Press, 7x11 inches inside chase, - - \$250. Boxing, \$ 6  
 No. 3.—Quarto-Med., 10x15 inches inside chase, with fountain, 425. " 7  
 No. 4.—Half-Med., 13x19 inches inside chase, with fountain, - 550. " 10  
 Steam Fixtures for either size, - - - - - 20.

Three Chases, two sets of Roller-Stocks, one Roller-Mold, one Hand-Roller and two Wrenches go with each Press.

**DEGENER & WEILER,**

23 Chambers Street, New York.

MANUFACTORY, Delancy, Tompkins and Mangin Streets.



## CAR

**Carpet Manufacturers.**

Dornan, Maybin & Co. Howard, cor. Oxford, Philadelphia

**Carpets, Importers and Dealers.**

**CHILDS, CROSBY & LANE,**  
116 Tremont, Boston

**GOLD THWAIT, SNOW & KNIGHT,** 33 Washington, Boston

**PRAY JOHN H. SONS & CO.**  
192 Washington, 23 Franklin and 63 Hawley, Boston

**Carriage and Sleigh Manufacturers.**

**KIMBALL BROTHERS,**  
110 and 112 Sudbury and Tremont, cor. Boylston, Boston

**Carriage Bolts.**

**TOWNSEND & HUBBARD,**  
2305 Cherry, Philadelphia. (See adv't.)

**Carriage Robes.**

**CHASE L. C. & CO.**  
36, 38 and 40 Sudbury, Boston

**Chair Manufacturer.**

**NICHOLS WILLIAM,**  
99 and 101 Cross, Boston

**Chemicals.**

**BAKER H. J. & BROS.**  
importers of chemicals, East India goods and French window glass. Manufacturers of refined saltpetre, refined camphor, bi-carb. soda and castor oil, 215 Pearl, New York

**Childrens' Carriages.**

**BRIDGMAN & PEABODY,**  
dealers in all kinds of children's vehicles, 8 Faneuil Hall Square, Boston

**A. CHRISTIAN,**

Manufacturer of

**Christian's Patent Spring Horses,  
Perambulators, Carriages, Cabs,  
ROCKING HORSES, PROPELLERS,  
SLEIGHS, Etc., Etc.**

Warerooms, 65 Maiden Lane, cor. William Street.

**MANUFACTORY, 87, 89, 91 and 93  
MANGIN STREET,  
NEW YORK.**

**SUMNER M. B.**

agent Manufacturers' Salesrooms, childrens' carriages, and base ball implements, 57 Temple place, Boston

## COF

**Chocolate and Cocoa.**

(Manufacturers.)

**PRESTON JOHN,**  
MANUFACTURER OF PREMIUM COCOA AND BROMA, VANILLA, SWEET FRENCH AND AMERICAN CHOCOLATES, 162 State, Boston

**Chromos.**

Willard Manufacturing Co. C. D. Burwell, treas. 631 Broadway, New York

**Clocks.**

(Manufacturers and Dealers.)

American Clock Co. 3 Cortland, New York  
**BANFIELD, FORRISTALL & CO.**  
28 and 30 Federal, and 105 Congress, Boston

**BUERK'S WATCHMAN'S  
TIME DETECTOR, J. E. Buerk, propr. 47 Congress, Boston (See adv't.)**  
Hodgens D. G. & Co. 1 Cortlandt, New York  
Waterbury Clock Co. 4 Cortlandt, New York

**Coach and Carriage Manufacturers.**

**BECKHAUS JOSEPH,**  
first class carriage builder, 1204 Frankford avenue, Philadelphia. (See adv't.)

**KILLAM H. & CO.**  
New Haven, Conn. (See adv't.)

**KIMBALL BROTHERS,**  
110 and 112 Sudbury and Tremont, cor. Boylston, Boston

**MANVILLE B. & CO.**  
manufacturers of first class light family carriages, 20 Wooster, New Haven

**RECH JACOB,**  
Carriage and wagon builder, clarence, park, phanton, Landau, buggy, etc. Girard avenue, cor. N. 8th Philadelphia. (See adv't.)

**ROGERS WM. D.**

Original and only manufacturer of the celebrated

**Rogers Carriage.**

1009 and 1011 Chestnut, Philadelphia. (See advertisement.)

**Coach Lamps.**

White Manufacturing Co. Bridgeport, Conn.

**Cocoa and Chocolate.**

(Manufacturer.)

**PRESTON JOHN,**  
162 State, Boston

**Coffee and Spices.**

**BERRY N. & SONS,**  
29 Central, Boston. (See adv't.)

## RIEHL'S PATENT STEAM-POWER Paper Cutting Machine

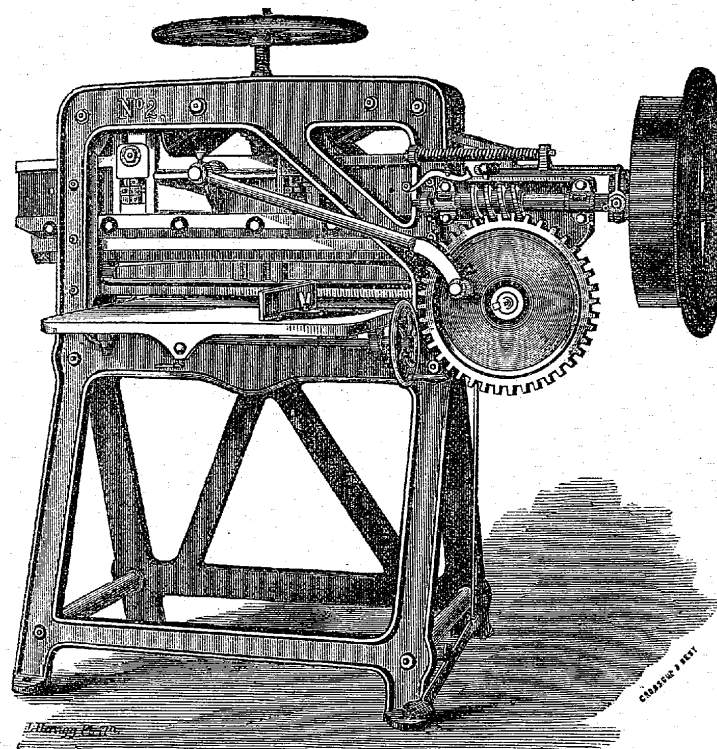

This machine is constructed the same as No. 1 Paper Cutter, as shown on back page, but expressly geared and arranged for working by steam power. It is made to throw itself out of gear as soon as the cut is effected, but can be stopped instantly at any height. It will cut the hardest paper with the utmost ease. It has a stationary and moveable side guide, so as to ensure the cutting of work perfectly true. It has an index at side of machine, and shows the exact distance in inches and parts of inches between edge of knife and rear gauge.

A great feature possessed by this machine is, that it can be worked by hand in case of temporary stoppage of steam, without a moments delay.

No. 2	Cutting Machine,	cuts 33 inches by hand,	\$400,	by power,	\$450
No. 4	"	" 36 "	"	"	\$500, " \$550
No. 5	"	" 39 "	"	"	\$600, " \$650

BOXING AND CARTING EXTRA.

**M. RIEHL, 1505 Willow St., Phila.,**

Manufacturer of Bookbinders' and Printers' Machinery.

# RIEHL'S PATENT PRINTERS' PAPER CUTTING MACHINE.

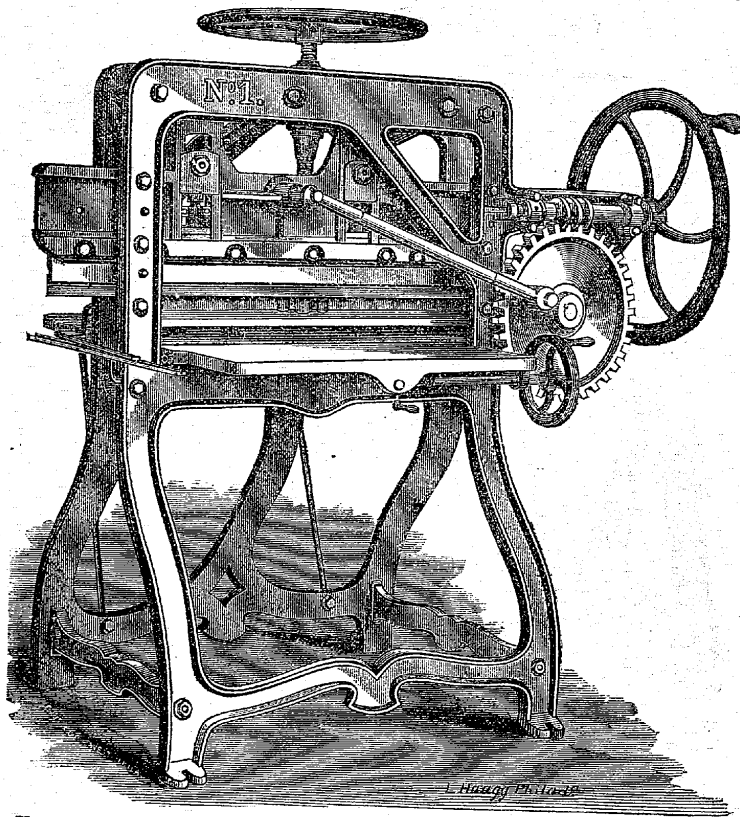

This is a hand machine and possesses immense power. The wheel has a continuous motion for both strokes of the knife, not requiring to be reversed for the up stroke. It has an index placed at the side of machine, and shows the exact distance in inches and parts of inches between the edge of knife and rear gauge. It has also a side gauge, cuts 32 inches.

Price \$300.00. Boxing and Carting Extra.

**M. RIEHL,**  
No. 1505 Willow Street, Philadelphia,  
Manufacturer of Bookbinders' and Printers' Machinery.

## COM

**Commission Merchants, Hardware.**

Wm. Thomas & Co. 29 Federal and 92 Devonshire, Boston

**Confectioners.**

**FOBES, HAYWARD & CO.**  
96 and 98 Sudbury, Boston. (See adv't.)

**Confectioner's Tools.**

United States Confectioner's Tool Works, Thos. Mills & Bro. machinists and manufacturers of all kinds of confectioners' tools, machines, moulds, etc. 901 and 910 Nassau, Philadelphia. Circulars sent on application.

**Cooking Extracts.**

**PRESTON & MERRILL,**  
inventors and manufacturers of infallible yeast powder, portable lemonade, cooking extracts, etc. Congress, cor. Purchase, Boston

**Cordage and Hemp.**

[Manufacturers.]

**LAWRENCE HENRY & SONS,**  
192 Front, New York

**WALL'S WILLIAM SONS,**  
manufacturers of cordage, and dealers in hemp, 113 Wall, New York

**Cork Manufacturers.**

**KEYSTONE CORK WORKS,**  
office and factory 829 and 831 N. 3d, Philadelphia.  
**ALFRED L. BUTZ,** importer of corks, corkwood and manufacturer of machine cut corks, also dealer in whitening, oil of vitriol, twines, etc.  
McQuade Henry, 70 Sudbury, Boston

**Cornices.**

[Manufacturer.]

**STEWART J. J.**

22 Beach, Boston. [See adv't.]

**Cotton and Cop Waste.**

**BISHOP ROBERT,**

dealer in cotton, cotton and cop waste and all kinds of paper stock, 213 Broad, Boston

**Cotton and Wool Finishing Machines and Loom Temples.**

**HOWARD GEO. C.**

17 S. 18th, Philadelphia. [See adv't.]

**Cotton Cards.**

Tally A. C. & Co. Whittemore's patent, 91 Maiden lane, New York

**Cotton Machinery.**

Hill & Chapman, 60 Pine, New York  
Providence Machine Co. 492 Eddy, Providence, R. I.

**Cotton Merchants.**

Emerson A. & Co. 324 Broad, Boston  
Lawton George & Co. 305 and 307 Broad, Boston

## EME

**Cutlery.**

**BANFIELD, FORRISTALL & CO.**  
28 and 30 Federal, and 105 Congress, Boston

**Cutters and Dies.**

**COYLE JOHN,**

manufacturer of CUTTERS AND DIES, Pevear's blk. Washington, Lynn, Mass.

**Detectors, Watchman's Time.**

**BUERK'S WATCHMAN'S TIME DETECTOR,** J. E. Buork, propr. 47 Congress, Boston. [See adv't.]

**Distillery Brands.**

**PENNY FRANK L.**

8 Dock Square, Boston

**Druggists and Glass Ware.**

**EXCELSIOR FLINT GLASS**

WORKS, Leach & McHugh, manufacturers and wholesale dealers in American flint and green glassware, 233 Greenwich, New York

**Druggists.**

[Wholesale.]

**BROWN FREDERICK,**

5th, cor. Chestnut, Philadelphia

**FOUGERA E.**

importing pharmacists, 30 N. William, New York  
Maynard & Noyes, 75 and 77 Water, Boston

**WILSON B. O. & G. C.**

wholesale botanic druggists, 18 and 20 Central

**Dusters, Russian.**

**REYNOLDS I.**

manufacturer of Russian dusters and ladies' hair switches and chignons, 4 Day, New York

**Edge Tools.**

**DOUGLAS AXE MANUFACTURING CO.** 215 Federal Boston

**Electricians.**

Williams Charles, jr. 109 Court, Boston

**Emblematic Signs.****WASHBURNE**

The Emblem Sign and Weather Vane

**MAKER -**

NO. 4 CORTLANDT STREET, . . . . . NEW YORK:

Send for Illustrated Price List.

**Emery.**

[Manufacturers.]

Smyrna Mills, Upton & Co. agents, 51 Kilby, Boston

WILLIAM C. DONALD.

CHARLES H. INGALLS.

**W. C. DONALD & CO.,**  
 MANUFACTURERS OF AND DEALERS IN  
 COMMON AND  
 FINE CUT AND BOOK INK, COLORED INKS AND VARNISHES,  
**Superior Printing Inks**

**French Lithographing Ink,**

**GOLD SIZE & BRONZES,**

**NO. 12 SPRING LANE,**

(FACTORY AT ANDOVER.)

**BOSTON, - - - MASS.**

**ESTABLISHED 1824.**

**NEW ENGLAND  
 TYPE  
 FOUNDRY.**

**64 & 66 Federal Street,**

Near opposite Franklin St.,

**Boston, Mass.**

**GEORGE G. BAILEY, JR., TREASURER.**

ENA

FRA

**Enameled Oil Cloths.**

**NENNINGER PETER,**  
 factory, Market, cor. Ferguson, Newark, N. J. office  
 and warehouse, 4 Warren, New York

**Engravers.**

Boytton G. W. 257 Washington, Boston  
 Pezney Frank L. 8 Dock Square, Boston

**Fancy Boxes.**

**CONANT A. & CO.**  
 12 Marshall, Boston

**Fancy Goods.**

**Banfield, Forristall & Co.,**

IMPORTERS AND DEALERS IN

**ENGLISH, FRENCH AND GERMAN**

**Fancy Goods,**

Pocket and Table Cutlery, Plated Ware,  
**YANKEE NOTIONS,**

**CLOCKS, STATIONERY, TOYS, ETC.,**  
 28 and 30 FEDERAL, and 105 CONGRESS STS.

**Boston - - - Mass.**

Wagner William E. 44 1/2 Maiden Lane, New York

**Feather Dusters.**

Alger J. R. 43 and 45 Walker, New York

**GOODENOUGH M. A.**

importer and sole manufacturer of the patent full  
 center feather dusters, 53 Day, New York

**Files.**

[Manufacturers.]



**CARR J. & RILEY,**

manufacturers of the celebrated dog brand, 82  
 John, New York

McCaffrey & Co. 1732 N. 4th, Philadelphia

**MOSS JOSHUA & GAMBLE**  
 BROS. 80 John, New York, and 512 Commerce,  
 Philadelphia

**Fire Apparatus.**

**HANNIS GEO. W.**

manufacturer of hose carts, hook and ladder trucks,  
 fire ladders, pike poles, hooks and chains, and all  
 kinds of fire apparatus. 76 Michigan, Chicago.

**Fire Arms.**

**WINCHESTER REPEATING**  
**ARMS CO.** manufacturers of Winchester and Spen-  
 cer repeating guns, New Haven, Conn.

**Fire Caps.**

**ANDERSON & JONES,**  
 manufacturers of fire caps, belts, shirts, etc. 199  
 Grand, New York

**Fire Hose.**

[Manufacturers.]

Dialogue & Greer, 520 North, Philadelphia

**Fire Supplies.**

**GATES JOSIAH & SONS,**  
 Lowell, Mass.

**Fish, Salt.**

Mansfield Charles H. & Co. 222 State, Boston

**Flag Makers.**

**ANNIN & CO.**  
 99 Fulton, New York

**S. McFadden & Co.,**

**MARITIME, NATIONAL AND FANCY**  
**FLAG MAKERS.**

Always on hand

**Ensigns Jacks, Pendants, Flies, Com-  
 mercial Code of Signals, Etc.  
 Bunting for Sale.**

**198 HUDSON, St. - NEW YORK.**

**Flax, Hemp and Cotton.**

**ROSS, PEARCE & CO.**  
 58 and 60 Milk, Boston

**Flour Dealer.**

**BOWDLEAR S. G. & CO.**  
 192 and 194 State, Boston

**Forges.**

**BOSTON FORGE CO.**

manufacturers of railroad work, locomotive frames,  
 axles, cranks, piston and connecting rods, truck  
 and car axles, etc. Steam marine work, etc. etc.,  
 Maverick, East Boston

**Frames, Looking Glass and Picture.**

**STEWART J. J.**

22 Beach, Boston. [See adv't.]

**WARD JOSEPH & SON,**

manufacturers of looking glasses, picture frames  
 and mouldings, importers and dealers in chromos,  
 engravings, photographs, albums, stereoscopes and  
 views, 125 Washington, Boston

Willard Manufacturing Co. C. D. Burwell, treas. 684  
 Broadway, New York

# JACOB RECH,

**Coach & Light Carriage Builder**

**EXPRESS AND BUSINESS WAGONS**

At Reasonable Terms, equal to any in the Trade.

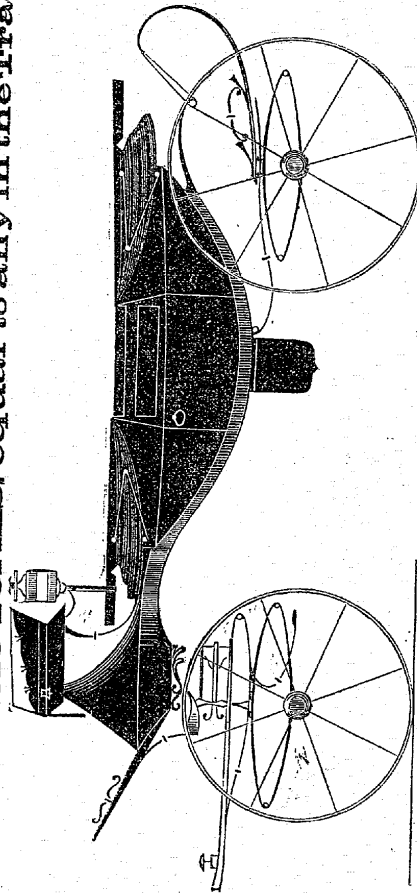

**REPAIRING PROMPTLY ATTENDED TO.**

**Family Coaches and Light Carriages,**  
Finished in the very best manner, of First Class Material, and in Style and Finish Second to None.

**N. EIGHTH STREET AND GIRARD AVENUE,  
PHILADELPHIA, PA.**

FRE

HAI

**CHAS. E. MEYER & CO.**

Manufacturers of all kinds of

**MOULDINGS,**

Oval, Pier and Mantle Frames,

**BASE AND CONSOL TABLES,  
CORNICES, Etc.**

Importers of and Dealers in

**Looking Glass Plates,  
AND FOREIGN WINDOW GLASS.**

—ALSO—

**Cords, Tassels, Knobs and Screw-Eyes  
Warehouse, 7 and 8 Holmes Bk.  
Haymarket Square.**

**Boston, - - - - Mass.**

**WILMURT THOS. A.**

Looking glass and picture frame establishment, 54  
E. 13th, New York

**WOERNER & HAUGER,**

manufacturers of gilt, rosewood and ornamental  
mouldings, looking glass, picture, portrait and  
photograph frames, also, mantle mirrors and cor-  
nicies of every description, 98 Chatham, New York

**French Burr Stone Grist Mills.**

**LEOEARD B. W.**

manufacturer of French burr mill stones, portable  
flooring and gr. st mills, and all kinds of mill ma-  
chinery, Bridgeport, Conn.

**Furniture Manufacturers.**

**NICHOLS WILLIAM,**

99 and 101 Cross, Boston

**PAINE J. S.**

chairs, bedsteads and chamber suits, and wholesale  
dealer in furniture of every description, 44 Canal,  
Boston

**Gas Fixtures.**

**TUCKER MANUFACTURING  
CO.** 117 and 119 Court, Boston, and 39 and 41  
Park place, New York

**Gas Pipes.**

Braman, Dow & Co. 3 and 4 Haymarket Square, Bos-  
ton

**Gilders.**

**STEWART J. J.**

22 Beach, Boston. [See adv't.]

**Glass, French Window.**

**BAKER H. J. & BRO.**

216 Pearl, New York

**Glass Stainers and Cutters.**

Boston Stained and Cut Glass Works, J. M. Cook, prop.  
131, 139 and 141 Congress, Boston

**WEST & HASTINGS,**  
95 Avon, Boston

**Glass Ware.**

**CORMERAIS HENRY & CO.**

importers of French and German China and Bohemian  
glassware, parian, lava, and kerosene goods,  
35 and 37 Federal, Boston

**Gluc.**

[Manufacturers.]

Wahl Bros. 229 Lake, Chicago  
Upton & Co. 51 Kilby, Boston

**Glucene.**

**GLUENE MANUFACTURING  
CO.** 24 Water, Boston

**Grindstones.**

**READ, STEVENSON & CO.,**

Manufacturers and Dealers in

**NOVIA SCOTIA AND BAY CHALEUR  
GRINDSTONES.**

Joggins, N. S.,

Bathurst, N. B.

**286 Commercial St., Boston.**

**Grocers.**

[Wholesale.]

**GREAT ATLANTIC AND PA-  
CIFIC TEA CO.** 8 Church, New York

**Gun Powder.**

[Manufacturers.]

**ORIENTAL POWDER CO.**

manufacturers of gunpowder, 160 State, Boston.  
W. H. Jackson, pres. E. F. Newhall, treas. (See  
adv't.)

**THE HAZARD POWDER CO.**

of Hazardville, Conn. manufacturers of gunpow-  
der, office, 89 Wall, New York city. A. C. Hissard,  
pres. Thos. S. Pope, sec.

**Guns and Pistols.**

**READ WILLAM & SON,**

dealer in fine guns, shooting and fishing tackle, 13  
Faneuil Hall Square, Boston  
Schaefer W. R. 11 Dock Square, Boston

**WINCHESTER REPEATING**

**ARMS CO.** manufacturers of Winchester and Spen-  
cer repeating guns, New Haven, Conn.

**Hair Work.**

Reynolds I. manufacturer of ladies' hair switches and  
chignons, 4 Day, New York

# HARTNETT & SALOMONS,

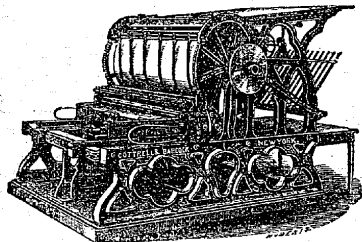

## PRINTERS' MACHINISTS,

No. 15 Province Street,  
Opposite City Hall,  
BOSTON, MASS.

We would respectfully inform you, that owing to the liberal patronage bestowed upon us, we have been compelled to increase our facilities for conducting our business, and have taken the large and commodious Rooms,

15 Province Street, Ground Floor, Opposite City Hall,

Where we shall be pleased to receive any orders for work in our line. Thankful for past favors, we shall endeavor to perform all orders you may favor us with, in a workmanlike manner, and on reasonable terms.

Having been for a number of years in the employ of R. HOE & CO., both in New York and Boston, we claim there is no press built but what we are competent to repair, and guarantee satisfaction in every instance. Printers having Cylinder Presses that slur, jar, or batter type, would do well to give us a trial. Particular attention paid to moving and setting up machinery of every description, and to repairing engines, hydraulic presses and machinery in general.

We shall also have on hand, castings to all parts of presses most likely to breakage, which will enable us to do repairs with very little delay to printers. Chases of all sizes, Roller Stocks, Cloth and Twine Rollers, furnished on short notice, and at reasonable rates. Cloth Rollers re-covered. Parties in want of Cylinder Presses, Job Presses, or Paper Cutters, would do well to give us a call

Shafting, Pullies, etc., furnished and put up to order.

Second-Hand Presses & Steam Engines Bought & Sold.  
HARTNETT & SALOMONS,

Agents for the SANBORN PAPER CUTTER, also Agents for COTTRELL & BABCOCK'S PRINTING PRESSES.

HAN

LAD

### Hand Cards.

WATSON L. S. & CO.  
Leicester, Mass.

### Hardware, Commission Merchants.

Wint Thomas & Co. 29 Federal, and 92 Devonshire  
Boston

### Hat and Bonnet Pressing and Stamp- ing Machines.

HOWARD GEO. C.  
17 S. 18th, Philadelphia. (See adv't.)

### Heavy Hardware.

MOSELEY & HODGMAN,  
75 Broad, Boston

### Hide and Leather Dealers.

CONVERSE & STANWOOD,  
56 and 58 High, Boston  
Davis, Emery & Co. 61 High, Boston  
SPOONER W. B. & CO.  
163 Congress, Boston

### Hoisting Machines.

HOWARD GEO. C.  
17 S. 18th, Philadelphia. [See adv't.]

McCALVEY ROBT.  
manufacturer of hoisting machines and dumb  
waiters, 602 Cherry, Philadelphia

MASON VOLNEY W.  
manufacturer of hoisting machinery for packing  
houses, mines and other purposes, Providence,  
R. I.

### Horse Clothing and Carriage Robes.

CHASE L. C. & CO.  
36, 38 and 40 Sudbury, Boston

SABIN & PAGE,  
118 Federal, Boston

### Hose Manufacturers.

Clark John, linen hose for fire engines, etc. 50 Con-  
gress, Boston

GATES JOSIAH & SONS,  
leather hose, Lowell, Mass.

### Ink Manufacturers.

JOHNSON CHARLES ENUE &  
CO. printing inks, 10th, cor. Lombard, Philadelphia,  
and 69 Gold, New York  
Maynard & Noyes, writing inks, 75 and 77 Water  
Boston

MORRILL & WINSLOW,  
printing inks, 22 Water, Boston. (See adv't.)

### Iron and Steel.

Moseley & Hodgman, 75 Broad, Boston

### India Rubber Goods.

HALE ALFRED & CO.  
manufacturers and dealers in India rubber good, in  
great variety.

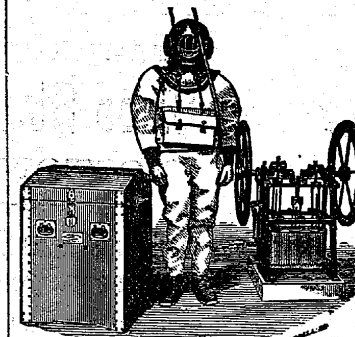

Manufacturer of Hale's Improved submarine armor and  
diving apparatus. Complete outfits constantly on  
hand, 23 School st. Boston, Mass.

### Iron Broker.

CUTLER E. P.  
15 Kilby, Boston

### Iron Pipe.

[Manufacturers.]

MORRIS, TASKER & CO.  
209 S. 3d, Philadelphia, and 15 Gold, New York

### Ivory Goods.

GROTE F.  
34 Fulton, New York

### Japanners.

Hodges and Coleman, 106 Sudbury, Boston

### Jewelry.

[Manufacturers.]

MERRILL, FITCH & ALLIN,  
19 John, New York

### Kerosene Lamps.

TUCKER MANUFACTURING  
CO. 117 and 119 Court, Boston, and 39 and 41 Park  
place, New York

### Lace Leather.

GATES JOSIAH & SONS,  
Lowell, Mass.

### Ladies' Shoes.

[Manufacturers.]

BLANCHARD CHARLES,  
118 Merrimack, Haverhill, Mass.

**STUDS INSTEAD OF EYELETS,***For Boots and Shoes,*

AND

**Self-Feeding Stud Setting Machines**

ARE MANUFACTURED AND FOR SALE BY

**Boston Shoe Stud & Button Co.,**

BOSTON, MASS.

**Studded Boots & Shoes for Ladies & Gentlemen,**

AND FOR MISSES' AND CHILDREN'S WEAR,

Are manufactured and for sale, by the following well known Manufacturers in Massachusetts.

ALEXANDER STRONG &amp; CO., Boston; HECHT BROS. &amp; CO., Boston; C. W. FORBUSH &amp; CO., Boston; DAVID CUMMINGS, Boston; T. W. &amp; L. P. HERSEY, Boston; B. F. SPINNEY, Lynn; J. F. VELLA, Lynn; W. H. SNOW, Marblehead, and others.

HENRY PICKFORD.

JOSEPH O. HOLLIS.

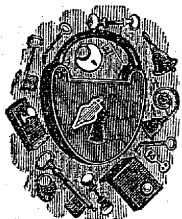
**PICKFORD & HOLLIS,***Manufacturers of***BANK, SAFE AND STORE****LOCKS, KNOBS***And House Trimmings,***MASONIC & ODD FELLOWS'****Working Tools,****ALARMS, BATON RESTS, ROD HOLDERS, ETC.,**

NO. 6 WASHINGTON STREET,

**BOSTON, - - MASS.**

## LAM.

## MAC

**Lamps and Chandeliers.****TUCKER MANUFACTURING**  
CO. 117 and 119 Court, Boston, and 39 and 41 Park  
place, New York**Lamps, Coach.**

[Manufacturers.]

White Manufacturing Co. Bridgeport, Conn.

**Lanterns.**Wilhelm & Neumann, manufacturers of hotel, hall and  
street lanterns, 919 and 921 Race, Philadelphia**Law Books.****BANKS BRO.,**

144 Nassau, New York

**Leather Belting.**

Clark A. N. &amp; Co. 31 Devonshire, Boston

**GATES JOSIAH & SON,**

Lowell, Mass.

**GRATTON & KNIGHT,**manufacturers of best stretched leather belts. Also,  
Page's patent lacing, 137 Front, Worcester, Mass.**Leather Hose.****GATES JOSIAH & SONS,**  
Lowell, Mass.**Linen Hose.**

Clark John, 50 Congress, Boston

**Lithographers.****NEW ENGLAND L I T H O .**  
GRAPHIC CO. show cards and drawings of ma-  
chinery, plain and in colors, 109 Summer, Boston.**Locksmiths.****PICKFORD & HOLLIS,**  
6 Washington, Boston. (See advt. opp.)**Looking Glasses.****CONANT A. & CO.**manufacturers of mirrors, portable desks and fancy  
boxes, 12 Marshall, Boston**MEYER CHAS. E. & CO.**7 and 8 Holmes blk. Haymarket Square, Boston.  
(See card under heading of Frame Manufacturers.)  
Ward Joseph & Son, 125 Washington, Boston**Looms.**

Compton George, Worcester, Mass.

**WOOD THOS.**

2106 Wood, Philadelphia

**Lozenges and Pipe.****CHASE & CO.**

114 and 116 Congress, Boston

**Machine Card Clothing.****EARLE T. K. & CO.**manufacturers of superior cotton, wool and flax  
**MACHINE CARD CLOTHING**, combing aprons  
for silk and worsted, etc. Worcester, Mass.

Gage D. T. 118 Market, Philadelphia

Hamden Card Co. Springfield, Mass.

**HOWE & GOODHUE,**

Lowell, Mass.

**LOWELL CARD CO.**manufacturers of machine card clothing of every  
description for cotton and woolen hand and strip-  
ping cards, Lowell, Mass.  
Newton James, Fall River, Mass.**ROBINSON D. F.**successor to Warren & Robinson, manufacturer of  
every description of card clothing for cotton and  
woolen machinery, Lawrence, Mass.**SARGENT CARD CLOTHING CO.**manufacturers of every variety **MACHINE**  
**CARDS FOR COTTON, WOOL AND FLAX**. Man-  
ufacturers' supplies, hand and stripping cards to  
order. Edwin S. Lawrence, supt. Worcester,  
Mass.**SMITH JAMES & CO.**manufacturers of all kinds of machine cards for  
cotton or woolen machinery, warranted of superior  
quality. Oak tanned leather. Marshall, cor. Wil-  
low, Philadelphia**STEDMAN S. M. & CO.**successors to Stedman & Fuller, manufacturers of  
card clothing for cotton and woolen machinery, and  
dealers in manufacturers' supplies, Lawrence,  
Mass.

Tully A. C. &amp; Co, 91 Maiden lane, New York

**WAITE E. C. & L. M. & CO.**successors to Smith & Waite, manufacturers of ma-  
chine, stripping and diamond pointed card clothing  
for cotton and woolen machines, Leicester, Mass.**WHITE A. & SON,**manufacturers of cotton and wool machine card  
clothing of every description, Leicester, Mass.**WHITTEMORE W. & J.**

Leicester, Mass.

**WOODCOCK J. & L. & CO.**

Leicester, Mass.

**WOODCOCK, KNIGHT & CO.**manufacturers of machine card clothing of every  
description, nappers, strippers, etc. Leicester,  
Mass.**Harness Needles.****CURRIER, PHILPOT & CO.**

5 Haymarket Square, Boston

**PHILLIPS O.**manufacturer of machine needles of every descrip-  
tion, 9 Washington, Lynn, Mass.**Machinists.****HARTNETT & SALOMONS,**printers' machinist, 15 Providence, Boston. [See  
advt.]**HAWES & HERSEY,**manufacturers of stationary, portable, and hoisting  
steam engines, Hersey's patent rotary pumps, sugar  
house machinery, moulding machines, press presses  
and general machinery, cor. 24 and E streets, South  
Boston

# HOWARD FOUNDRY AND MACHINE WORKS.

GEO. C. HOWARD, 17 S. EIGHTEENTH ST., PHILADELPHIA.

MANUFACTURES

**Machinist's Tools, Steam Engines and Boilers,  
SAFETY HOISTING MACHINERY AND DUMB WAITERS,**

For Factories, Stores, Depots, Hotels and Ice Houses, for hand or power, with self-closing doors, Shafting, Pulleys, Mill Gearing, Couplings and Hangers; Grindstone Boxes and Patent Machines for keeping Stones true. Punching, Cutting and Perforating Machines for Paper or Metals, Patent Forming Presses for Felt, Buckram, or Sheet Metal.

**Hydraulic Screw or Lever Presses.**

Plate and Lithographic Presses for hand or power. Calendars and Embossers, with Chilled Iron or Steel Rolls. Cotton and Wool Finishing Machines, such as Shears, Brushes, Napping and Fulling, Lapping and Measuring Machines and Loom Templates.

Design and Construct New Machinery, Make Models and Patterns.

Reliable and Skillful Millwrights, Machinists and Boiler Makers furnished for erecting and repairs.

**Welch, Harrison & Co.**  
644 Federal Street, South Boston, Mass.

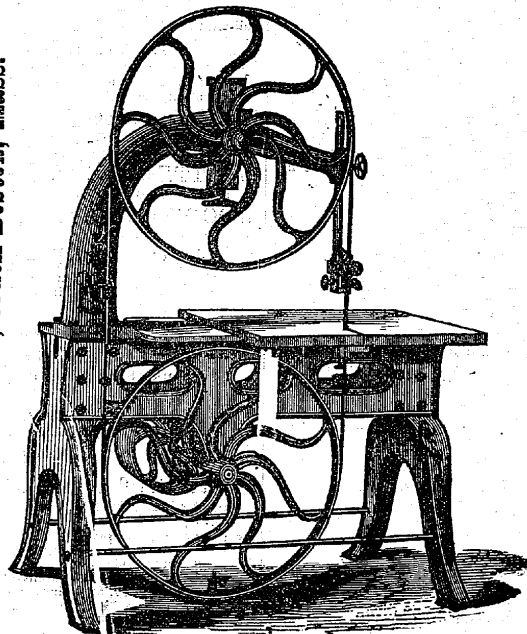

**BANDSAW MACHINE  
MANUFACTURERS.**

MAC

NEA

VOLNEY W. MASON &amp; CO.

Manufacturer of

COUPLING.

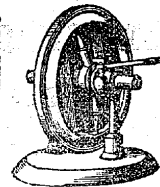

**Patent Friction  
COUPLINGS,**

ALSO,

**Friction Pulleys,  
HOISTING**

Patented Feb. 25, 1869.

**Machinery.  
For packing Houses, Mines and Other  
Purposes.**

PROVIDENCE, - - - - R. I.

MEAD &amp; ADDY,

machinists and brass finishers, makers and designers of light machinery, watch and jewelers' lathes, tools, etc. Special attention paid to dies for cutting and forming metals. Screw and lever presses on hand and made to order, 2 Bath, Boston

POTTLE BROS.

machinists, manufacturers of air and sub-marine pumps, dies of all kinds, machines of all descriptions made and repaired, models of all descriptions made, and strictly confidential. 71 Sudbury, Boston

Machinists' Tools.

HOWARD GEO. C.

17 S. 18th, Philadelphia. [See adv't. opp.]

LATHE &amp; MORSE,

manufacturers of machinists' tools, engine lathes, planing machines, milling machines, crank planes, chuck lathes, drilling lathes, bolt cutters, upright drills, plane jaws and centers, lathe chucks, Worcester, Mass.

Star Tool Co. 236 Washington, Providence, R. I.

THOMAS IRON WORKS,

manufacturers of Thomas' patent lathes, upright drill, planing machines, planer centers, chucks, etc. Worcester, Mass.

Wood, Light &amp; Co. Worcester, Mass. Warehouse, 107 Liberty, New York

Manufacturers' Supplies.

Gege D. T. 118 Market, Philadelphia

GATES JOSIAH &amp; SONS,

Lowell, Mass.

Matches.

(Manufacturers)

EPHRAIM K. SMITH,

Manufacturer of

Parlor, True Blue, Water Proof and White Head

**MATCHES,**

919 St. John Street, (above Poplar),

PHILADELPHIA.

Meerscham Goods.

Kaldenberg F. J. 4 and 6 John, and 71 Nassau, New York

**POLLAK & SON,**

Manufacturer of Genuine



Meerscham Goods.

All Goods Warranted.

PIPES CUT TO ORDER, REPAIRED AND MOUNTED.

Amber Work and Boiling Done.

519 Broadway, and 27 John, New York.

Metals.

HOOK'S SMELTING CO.

metallurgists, smelters and brass founders, manufacturers of type, stereotype, rabbit and anti-friction metals, Broad, cor. Hamilton, Philadelphia

Mill Supplies.

WELCH &amp; GRIFFITHS,

Boston

Morocco.

(Manufacturers.)

MOULTON JOHN T.

50 Market, Lynn, Mass.  
Wentworth Jacob S. goat and colored roans, 34 and 36 Market, Lynn, Mass.

Mouldings.

WOERNER &amp; HAUGER,

manufacturers of gilt, rosewood and ornamental mouldings, 88 Chatham, New York

Musical Instruments.

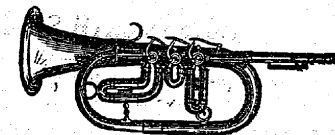

HALL &amp; QUIMBY,

manufacturers of rotary valve musical instruments of every description, 62 Sudbury, Boston

KLEMM &amp; BRO.

importers of musical instruments, violin strings etc. 705 Market, Philadelphia

Neatsfoot Oil.

Wahl Bros. 229 Lake, Chicago

**PENNEY'S  
PATENT  
Revenue Burning Brands  
FOR DISTILLERS**

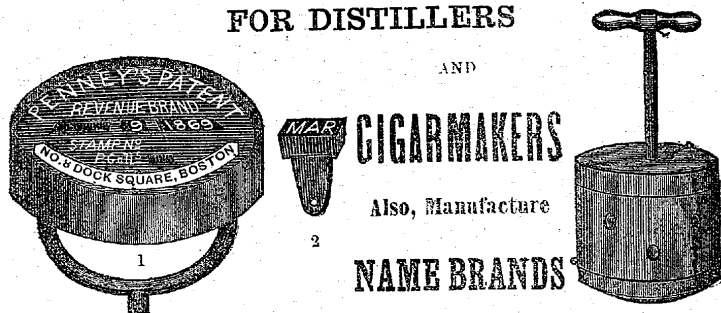

**For Farmers, Manufacturers' Garden Tools,**

Also, Facsimiles for Whisky Dealers, Cigar Boxes, &c. Also, Steel Stamps, Alphabets, Figures &c., warranted to stamp steel. Die sinking in all its varieties, and in the most artistic styles.

**Omega Brand Co.,  
No. 8 Dock Square, Boston, Mass.**

**FRANK L. PENNEY, Agent.**



Respectfully informs Publishers, Printers and business men generally, that he is prepared to execute all orders for Wood Engravings, including

**BOOK ILLUSTRATIONS, NEWSPAPER & HEADINGS,  
OTHER  
PORTRAITS,  
Views of Buildings, &c.**

N. B. Orders sent per mail or express, if accompanied by Photographs, Sketches or other accurate information, will receive prompt attention.

NEE

PAT

**Needles.**

[Manufacturers.]

**CLARK GEO. A. & BRO.**

sole agents for Millward's Helix Needles, 88 Reade, New York

**Oil Clothes.****NENNIGER PETER,**

manufacturer oil table, enameled and stair oil cloths. Factory, Market, cor. Ferguson, Newark, N. J., office and warehouse, 4 Warren, New York

**Ornamental Iron Works.****PHILADELPHIA ORNAMENTAL IRON WORKS,** Robert Wood & Co. 1132 Ridge av. Philadelphia**Paint Manufacturers.****TREMONT PAINT WORKS,**

Briggs &amp; Robinson, proprs. 31 and 33 Battery-march, Boston

**Paints, Oils, Etc.**

(Wholesale.)

**BRIGGS & ROBINSON,**

31 and 33 Battery-march, Boston

**LUCAS JOHN & CO.**

sole manufacturer of the imperial French green and Swiss green, free from all poisonous matter, 141 and 143 N. 4th, Philadelphia

**PECORA PAINT COMPANY.**

**CHEAP PAINTING.**—  
100 lbs. of the PECORA COMPANY'S  
COLORED PAINT (costing \$12.50) will  
paint as much as 250 lbs. of Lead,  
and wear longer. For particulars,  
address S. BOWEN, Sec'y, No. 150  
North 4th St., Philada.  
COST LEAD.  
or 75 Malden Lane, N. Y.

**Paper Folding Machinery.**

Chambers, Bro. &amp; Co. 3001 Chestnut, Philadelphia

**Paper Stock.**

Ring M. A. &amp; Sons, paper stock, gunny cloth and bale rope, 215 Broad, Boston

**Parlor Billiard Tables.****BRIGGS OLIVER L. & CO.**

578 Washington, Boston

**Pattern and Model Makers.**

Coffin Galen, 17 Harvard place, Boston

**Perforating and Cutting Machines.****HOWARD GEO. C.**

17 S. 18th, Philadelphia. (See adv't.)

**Parlor Brackets.****C. W. STROUT & CO.**

Manufacturers of

**PARLOR BRACKETS, BOOK RACKS,  
TOILETS, ETC., ETC.**

Being the only house in the United States who confine ourselves exclusively to the manufacture of the above articles. We keep on hand a larger stock, and greater variety than any other concern. Our Goods are made from the best seasoned stock, finished in oil of shellac, and warranted not to soil the finest room paper.

Photographs and price list may be had on application.

**C. W. STOUT & CO.,**

14 Charlestown St., Boston.

**Patent Leather.**

**BRIDGEPORT  
Patent Leather Manufacturing Co.  
MANUFACTURERS OF**

Charter Oak



Brand

**PATENT ANODIZED  
LEATHER:  
ESTABLISHED 1849.  
Bridgeport, Conn.**



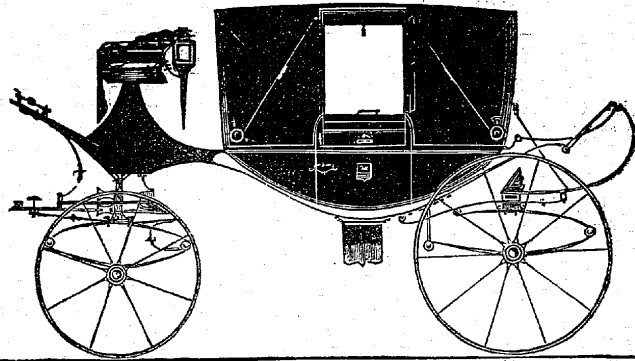

**Joseph Beckhaus**  
**FIRST-CLASS**  
**CARRIAGE**  
**BUILDER,**  
 1204 FRANKFORD ROAD, ABOVE GIRARD AV., PHILADELPHIA.

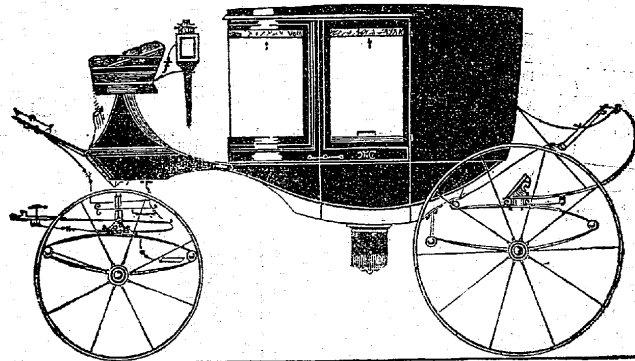

**CLARENCE COACHES,**  
**CLOSE AND SHIFTING QUARTER COACHES,**  
**LANDAUS, LANDAULETTES,**  
**BAROUCHES, PHAETONS, HEARSEES, &c., &c.**

## PHO

**Photograph Materials.****EATBERG LEWIS & BRO.**

manufacturers of and dealers in all kinds of paper-partouts, display cards, mats, etc. 561 and 563 Broadway, New York

**Photograph Publisher.**

sole John P. 199 Washington, Boston

**Planing Machine Knives.****LOVEJOY DANIEL,**

manufacturer of paper mill engine bars and plates, rag cutters, trimming knives, etc. Lowell, Mass.

**Plated Ware.****CURRAN J. F. & CO.**

18 John, New York

**Plumbers.****LOWELL R. M.**

dealer in water closets, wash basins, force, copper and beer pumps, bathing tubs, cess-pools, brass and silver plated cocks, lead pipe, sheet lead, etc. 186 Blackstone, Boston

**MILLS WM. & CO.**

28 and 30 Congress, Boston

**Plumbers' Materials.****MCCAMBRIDGE & ROBINSON,**

manufacturers of castings, valves, cocks, etc. for machinists, plumbers, copper-smiths, gas and steam fixtures, 523, 525 and 527 Cherry, Philadelphia

**MILLS WM. & CO.**

wholesale dealers in all kinds of plumbing materials, also seamless brass tubes and fittings for plumbing work, 28 and 30 Congress, Boston

**Plumbers' Supplies.****JONES J. & H. & CO.**

16 W. 4th, New York

**Polishing Powder.**

Mt. Eagle Manufacturing Co. manufacture Tripoli powder and soap. Johannot & Saunders, agents, 21 Dock Square, Boston

**Portable Desks.****CONANT A. & CO.**

12 Marshall, Boston

**Printers' Machinery.****HARTNETT & SALOMONS,**

15 Province, Boston. [See adv't.]

**RIBHL M.**

1505 Willow Philadelphia. [See adv't.]

**Printers' Rollers.****WILD CHAS. D. JR.**

20 Spring lane, Boston

## PRI

**Power Looms.****FAIRMOUNT MACHINE WORKS,**

2106 Wood Street, Philadelphia, Pa.

**THOMAS WOOD,**

MANUFACTURER OF

**POWER LOOMS,**

Spooling, winding, beaming, dyeing and sizing machines, self-acting wool-scouring machines, hydro-extractors.

Plans taken and factories fitted out complete with

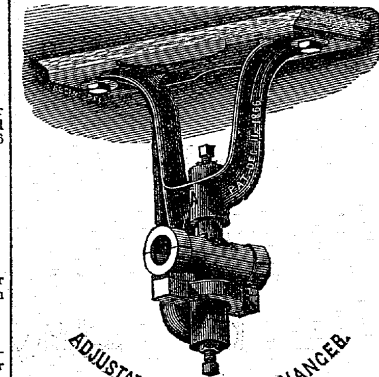
**Shafting and Gearing****Power Hoisting Machines.**

Shafting, Pulleys, Couplings and Self-Oiling Hangers Adjustable or Rigid Bearing always on hand.

**Printers' Materials.****Galen Coffin,**

PATTERN AND MODEL MAKER AND

**PRINTERS' JOINER.**

Manufactures

**Stereotype Blocks**

With Modern Improvements.

The best article in use, constantly on hand, or made to order at the shortest notice. Furniture and Beglet, Case Stands, Press Boards, Hand Rollers, Planers, Galleys, Ink and Form Tables, Chases, Mallets, Shooting Sticks, Job Sticks, Quoins, Wood Rule, Wood Circles, Wood (vals, Wood for Engravers, Cuts Blocked. 71 Harvard place, Boston

# N. BERRY & SONS,

Wholesale Dealers and Manufacturers of

# PURE SPICES,

## Pure Coffees,

## PURE CREAM TARTAR, MUSTARD, SODA, ETC.,

No. 28 Central Street,

BOSTON, - - - - - MASS.

# Fobes, Hayward & Co.

Manufacturers of and Wholesale Dealers in

# CONFECTIONERY,

CHOCOLATE, SUGAR TOYS, &c.

Nos. 96 & 98 SUDBURY STREET,

**BOSTON.**

MANUFACTURERS OF

The Celebrated English Coltsfoot Rock Candy.

PRI

SEW

### Printing Ink.

[Manufacturers.]

Johnson Charles Enue & Co. 10th. cor. Lombard, Philadelphia, and 59 Gold, New York  
**MORRILL & WINSLOW,**  
 22 Water, Boston. [See adv't.]

### Printing Presses.

**DEGENER & WEILER,**  
 23 Chambers, New York. [See adv't.]  
**GEO. P. GORDON,**  
 Franklin job and card press, 96 Fulton, New York

**EVERY MAN HIS OWN PRINTER.**



Young and Old Making Money.  
 Price of Presses \$8, \$12, \$16, \$23.  
 Price of Office with Press \$15, \$20, \$30,  
 and \$42.

Send for Circular to

**LOWE PRESS CO.**

15 Spring Lane, Boston.

### Railroad Spikes.

Winch Corydon, Canal, near 2d and Laurel, Philadelphia

### Railroad Supplies.

Wilhelm & Nerman, manufacturers of lamps, brass and German silver car trimmings, 919 and 921 Race, Philadelphia

### Regalia Manufacturers.

**POLLARD & LEIGHTON,**  
 104 Tremont, Boston

### Revenue Brands.

**PENNEY FRANK L.**  
 8 Dock Square, Boston

### Roofing, Felt and Composition.

**NEW ENGLAND FELT ROOFING CO.** manufacturers and proprietors of the celebrated Warren felt composition roofing materials, paving pitch, etc. 5 Liberty Square, Boston

### Saddlery Hardware.

**SABIN & PAGE,**  
 118 Federal, Boston

### Safe Manufacturers.

**AMERICAN STEAM FIRE PROOF SAFE COMPANY,**

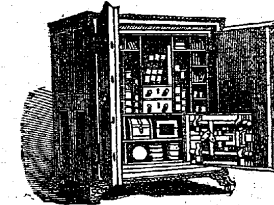

STEAM FIRE PROOF SAFES.  
 Welded Steel and Iron Burglar Proof Safes

—AND—

**BANK VAULTS.**  
 SEND FOR DESCRIPTIVE CIRCULAR.

### Sand Paper and Emery.

Upton & Co. 51 Kilby, Boston

### Saw Machines, Band.

[Manufacturers.]

**WELCH, HARRISON & CO.**  
 644 Federal, Boston. [See adv't.]

### Saw Manufacturers.

### HENSHAW & CO.

manufacturers of warranted cut steel saws of every description, 31 Exchange, room 2, Boston

### MONIECE WILLIAM,

saws of every description made and repaired, 407 Cherry, Philadelphia

### WELCH & GRIFFITHS,

established 1830, manufacturers of patent ground and Warranted Cast Steel Saws, and dealers in mill supplies, Boston. Branch house, Detroit, Mich.

### Seeds.

### PARKER & GANNETT,

49 N. Market and 46 Merchants' row, Boston

### Segar Brands.

### PENNEY FRANK L.

8 Dock Square, Boston

### Self-feeding Eyelet Machines.

Butterfield William, 26 Pearl, Boston

### Sewing Machine Needles.

### CURRIER, PHILPOT & CO.

5 Haymarket Square, Boston  
 Phillips O. 9 Washington, Lynn, Mass.  
 Howe Sewing Machine, Nichols & Baldwin, gen. agents,  
 136 Washington, Boston

# Union Vise Company

OF BOSTON.

STORE, NO. 61 WATER ST., BOSTON, MASS.

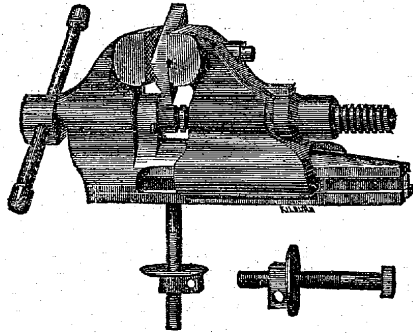
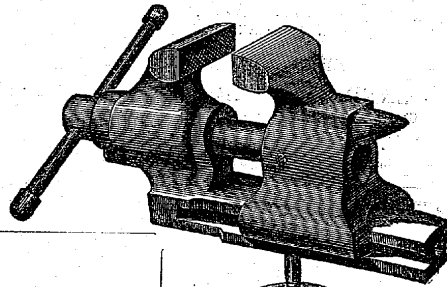
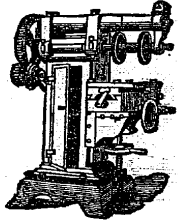

Covered Screw.

**FIFTY**

Styles and Sizes

Pipe Vise, Extra Jaw.

**VISES!**

Constantly on hand and warranted.

**MILLING MACHINES,**

Five Sizes.

Very simple, easily adjusted and of great power weighing 2,300, 1,600, 1,050, 1,000 and 500 pounds.

For Sale by the Trade.

G. H. NOTT, Pres.

A. H. BRAINARD, Supt.

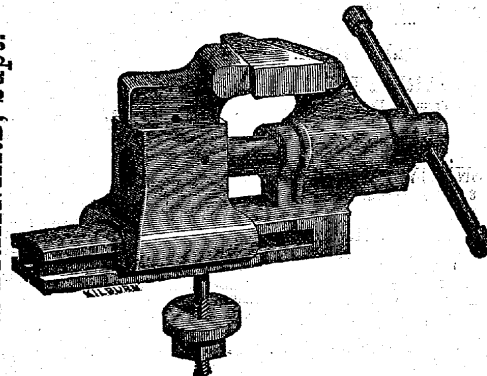

Swivel Jaw.

SHI

SPO

### Ship Chandlers.

Fearing, Rodman & Swift, 23 and 25 Commercial, Boston

### Ship Machinists.

Wells Wm. H. & Co. 106, 108 and 110 Cannon, New York

### Shipping and Commission Merchants.

Warders Charles & Co. 119 and 123 Commercial, Boston

### WARREN & CO.

132 State, Boston

### Shipping Tags.

### DENNISON & CO.

Boston, New York, Philadelphia and Chicago [See adv't.]

### Shirt Manufactory.

### C. CAPEN,

Manufacturer of the

### Golden Hill Shirts,

BRIDGEPORT, CONN.

Orders received at the Factory.

Sullivan W. M. Bridgeport, Conn.

### Shoe Manufacturers' Goods.

Butterfield, Wm. 26 Pearl, Boston

### Shoe Studs.

BOSTON SHOE STUD AND BUT-  
TON CO. 2 Pearl, Boston. [See adv't.]

### Shovel Manufacturers.

BROWN & SHERMAN,  
Middleboro, Mass. and 119 Milk, Boston

### Show Cases.

### LORENZ A.

13 N. William, New York

### Silver Plated Ware.

### CURRAN J. F. & CO.

manufacturers and importers of fine silver plated ware of every description 18 John, New York

### Silver Ware.

### KRIDER & BIDDLE,

manufacturers of sterling silver ware, 618 Chestnut, Philadelphia

### Soap Manufacturers.

Tufts J. W. & Co. fine toilet soaps, 66 Union, Boston and 26 Maiden lane, New York

### Soda Water Apparatus.

### DOWS G. D. & CO.

ice cream soda water apparatus, 55 Sudbury, Boston

### LIPPINCOTT CHARLES,

manufacturer of soda water apparatus, of all kinds, such as marble apparatus, silver plated urns, jets, generators, copper (block tin lined) and iron, porcelain lined, fountains, etc. etc. All repairing promptly attended to, 916 Filbert, Philadelphia. Send for pamphlet

### MORSE ANDREW J. & SON,

122, 124 and 126 Congress, Boston

### PUFFER A. D.

manufacturer and dealer at wholesale and retail, of plumbers' materials, soda water and beer apparatus. Particular attention paid to fitting up cabinet, or English style of ale pumps, in the most elaborate manner known to the trade, 48 Portland, Boston

**The Best is the Cheapest!**

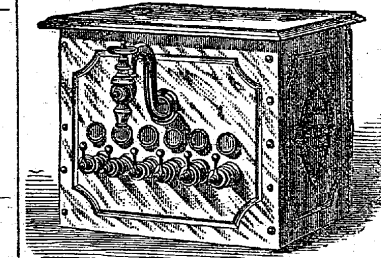

### TUFTS' PATENT

An Apparatus Durable and Popular. A  
Richly Ornamental and very attractive. P  
Cannot be equalled for Convenience. P  
The Leading Fountain in the Market. A  
Is exceedingly Economical in use of Ice. R  
Cans made of pure Solid Block Tin. A

Simplicity its best and crowning feature. T  
Only Fountain in use of Practical Merit. U  
Dispenses "Artic"-Cold Soda Water S  
And satisfies a host of constant patrons.

SEND FOR A PAMPHLET.

**JAMES W. TUFTS,**  
BOSTON, MASS.

### Spices.

### BERRY N. & SONS,

28 Central, Boston. [See adv't.]

### Spool Cotton,

Auchincloss J. & H. agents for J. & P. Coats, 108 Duane, New York

### CLARK GEO. A. & BRO.

sole agents for Clark's O. N. T. spool cotton and Milward's Helix needles, 88 Reade, New York



**The Philadelphia**  
**STAR**  
**Carriage & Tire Bolts,**  
**Axle Clips,  Stove Bolts**  
TRADE MARK.  
**AND**  
**RODS,**  
**MACHINE BOLTS, WOOD SCREWS, PLOW BOLTS, &C.**  
**Townsend & Hubbard,**  
2305 Cherry Street, Philadelphia.

**BRIDGEPORT**  
**Spring Company,**

MANUFACTURERS OF FINE

    
**Carriage Springs and Axles,**

East Washington Avenue,

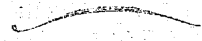
    
Opp. Pacific Iron Works, **BRIDGEPORT, CONN.**

Parties furnishing their own Drafts for any Special Pattern in Half Springs, Scroll or French Platform, and C Springs, may rely upon faithful attention to instructions.

W. H. ROCKWELL, Sec.

EDWIN BANKS, Treas.

SPO

STE

**Spools and Bobbins.**

Watson Edward F. Méchanics' Mills, Lowell, Mass.

**Spring Beds.**

LIPPENCOTT & CO.  
only manufacturers and agents for Wright's pat-

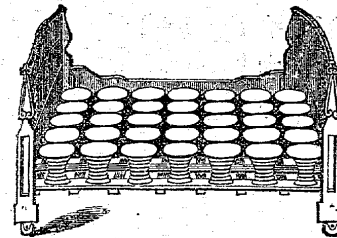

ent spring bed. Manufacturers of Deetz's patent adjustable sofa bed, depot, 171 Canal, New York  
**TUCKER MANUFACTURING**  
CO. 117 and 119 Court, Boston, and 39 and 41 Park place, New York

**Springs and Axles.**

**BRIDGEPORT SPRING CO.**

W. H. Rockwell, sec. Edwin Banks, treas. Bridgeport, Conn. (See adv't. opp.)

**Stable Brooms.**

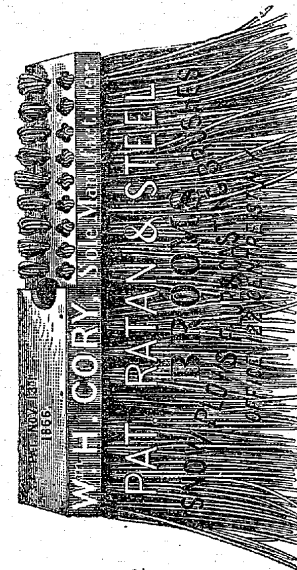

**Stained and Cut Glass.**

Boston Stained and Cut Glass Works, J. M. Cook, prop  
131, 139 and 141 Congress, Boston

**WEST & HASTINGS,**  
95 Avon, Boston

**Starch and Maizena.**

**DURYEA'S STARCH AND MAI-**  
**ZENA,** Glen Cove Starch Manufacturing Co. Wm. Duryea, gen. agent, 49 and 51 Park place, New York

**Steam and Gas Pipe.**

Bratman, Dow & Co. 3 and 4 Haymarket Square, Boston

**Steam Engines.**

**HAMPSON & COPELAND,**  
WOOD & MANN STEAM ENGINES, IRON AND WOOD WORKING MACHINERY, 42 Cortlandt, New York, P. O. Box 5767

**MEYER C. WEST,**

Steam engine builder, and dealer in steam engines, boilers, machinery, etc. 245 N. Front, Philadelphia. Reliable references throughout the States.

**Steam Gauges.**

Ashcroft E. H. 51, 53 and 55 Sudbury, Boston

**Steam Heating Apparatus.**

**FARRER S. & CO.**

Engines, 212 Grand street, New York. Manufacturers of high and low pressure STEAM HEATING APPARATUS, for warming and ventilating hotels, private residences, churches, schools, stores, factories, steamers, etc. and dealers in brass and iron valves. Gauges and cocks of all descriptions, wrought iron pipe and fittings for steam, gas and water engines, boilers, steam pumps, shafting, pulleys, etc. Geo. A. Barnard, supt.

**Steam Pumps.**

**BLAKE GEO. F. & CO.**  
51 Chardon, Boston

**Steamboat Lines.**

**FALL RIVER AND NEWPORT**  
LINES, Geo. Shiverick, passenger and freight a. t.  
3 Old State House, Boston

**Steel.**

[Manufacturers and Importers.]

**CARR J. & RILEY,**  
82 John, New York

**HOBSON FRANCIS & SON,**  
proprietors of the most excellent and enduring brand of "CHOICE" cast steel, 97 John, New York and 43 E. 2d, Cincinnati

**MOSS JOSHUA & GAMBLE**

BROS. 80 John, New York, and 512 Commerce, Philadelphia

**Steel Pen Manufacturers.**

Gillott Joseph & Sons, Henry Owen, agt. 91 John, New York

**H. KILLAM & Co.**  
**MANUFACTURERS OF**  
**Fine Carriages!**

CONSISTING OF

**COACHES, CALAISCHES, CLARENCE**

**Landaus, Landulettes,**

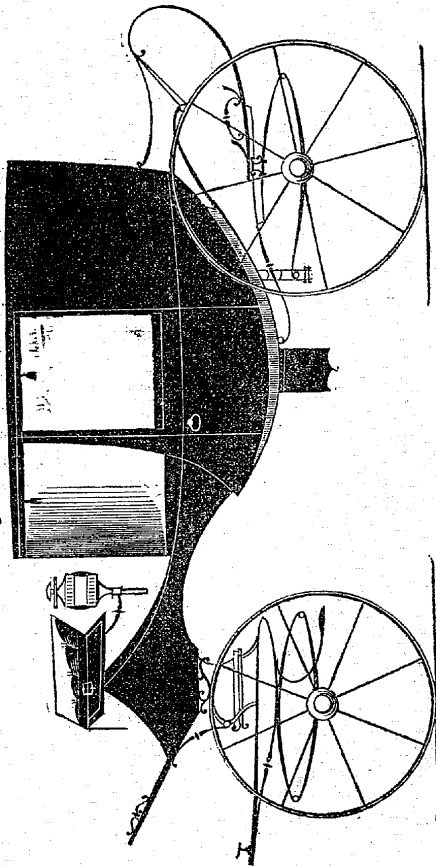

**COUPES, COUPÉLETTES, BRETTIS,**  
**Rockaways and Phaetons.**

No. 29 Chestnut Street, New Haven, Conn.

STE

WAT

**Stencil Tools and Stock.**

**METCALF L. S.**  
 101 Union, Boston

**POPE JOHN & SON,**  
 8 Dock Square, Boston

**Stereoscopes.**

Willard Manufacturing Co., C. D. Burwell, treas.  
 684 Broadway, New York.

**Surveying Instruments**

Stackpole & Bro. 41 Fulton, New York

**Table Oil Cloths.**

**NENNINGER PETER,**  
 factory, Market, cor. Ferguson, Newark, N. J.  
 office and warehouse, 4 Warren, New York.

**Tag Manufacturers.**

**DENNISON & CO.**  
 Boston, New York, Philadelphia and Chicago.  
 (See adv't.)

**Telegraph Instruments.**

**WILLIAMS CHAS. Jr.**

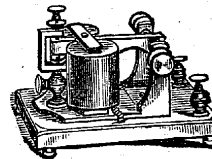

Successor to Hinds & Williams, manufacturer of telegraphic and magnetic apparatus, galvanic batteries, etc., wholesale and retail dealer in telegraph supplies, 109 Court, Boston.

**Ten Pin Balls and Pins.**

**GROTE F.**  
 84 Fulton, New York

**Time Detectors, Watchman's.**

**BUERK'S WATCHMAN'S TIME**  
 DETECTOR, J. E. Buerk, propr. 47 Congress,  
 Boston. (See adv't.)

**Toys.**

Banfield, Farristall & Co., 28 and 30 Federal, and  
 105 Congress, Boston  
 Wagner Win. E. 44½ Maiden Lane, New York

**Trunks.**

Easter & Winship, 7 Elm, Boston

**Truss Makers.**

The Elastic Truss Co., G. V. House, gen. supt. 683  
 Broadway, New York

**Turner, Wood and Ivory.**

**BYRNES L.**

manufacturer of Fossenden's Patent Castanets,  
 a new and amusing toy for children, also Base  
 Ball and Cricket Implements, Indian Clubs,  
 Dumb Bells, Ten Pins and Balls, etc. 17 Har-  
 vard Place, Boston

**Twine.**

Clark Jeremiah, 96 Middle, Lowell, Mass  
**ROSS, PEARCE & CO.**  
 58 and 60 Milk, Boston

**Type Founders.**

**CHICAGO TYPE FOUNDRY,**  
 MARDER, LUSE & CO. 139 Monroe, Chicago.  
 (See adv't.)

**NEW ENGLAND TYPE FOUN-  
 DRY,** George G. Bailey, jr. treas. 64 and 66  
 Federal, Boston. (See adv't.)

**Umbrellas.**

**WILLIAM A. BROWN & CO.,**

MANUFACTURERS OF SUPERIOR

**Umbrellas and Parasols,**

246 Market Street, Philadelphia.

Warerooms, in New York, 454 Broadway.

**Varnish Manufacturers.**

**VALENTINE & CO.**  
 manufacturers of Varnish and Japans, and sole  
 agents for the United States of Piotrowski's  
 Permanent Wood Filling, 32 Kilby, Boston

**Vise Manufacturers.**

**UNION VICE COMPANY OF**  
 BOSTON. G. H. Nott, pres., A. H. Brainard,  
 supt. 61 Water, Boston. (See adv't.)

**Waste.**

**SHERBURNE & CO.**  
 21 Federal, Boston

**Watch Clocks.**

**BUERK'S WATCHMAN'S TIME**  
 DETECTOR, J. E. Buerk, propr. 47 Congress,  
 Boston. (See adv't.)

**Watches and Jewelry.**

**ELGIN WATCHES,**  
 FOR SALE BY ALL JEWELERS IN CHICAGO.

**TIFFANY & CO.**  
 550 and 552 Broadway New York

# CHARLES SEARS, ENGRAVER ON WOOD,

LITHOGRAPHER AND PRINTER,

**66 Fulton St., New York.**

Plain and Fancy Labels got up in the Finest Style. Also, Illustrated Posters for Theatres, Concerts, etc., etc. Illustrations of Dwellings, Machinery, Hardware, Cutlery, etc.

## Eagle Printing Ink Works,

Formerly Works of L. MARTIN & CO. of Philadelphia.

**MORRILL & WINSLOW,**

Proprietors and Manufacturers of

BOOK, NEWS, CARD

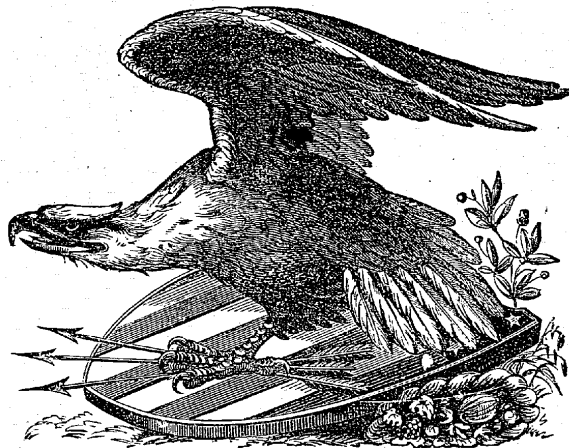

AND JOB INKS,

ALSO FINE WOOD CUT INKS.

OFFICE, No. 22 Water Street,

S. S. MORRILL,  
E. F. WINSLOW }

BOSTON, MASS.

WAT

YEA

Watchman's Time Detector.

**BUEK'S WATCHMAN'S TIME  
DETECTOR**, J. R. Buek, propr. 47 Congress,  
Boston. (See adv't.)

Wax Thread Sewing Machines.

Butterfield William, 26 Pearl, Boston

**KRIEG J. K. & CO.**  
44 Warren, New York

Whips.

(Manufacturers.)

**BURDITT & WILLIAMS,**  
agents for American Whip Co. 20 Dock Square,  
Boston.

Window Glass.

Importers and Dealers.)

**Hills, Turner & Harmon,**

Importers and Dealers in

**WINDOW GLASS,**

Polished and Rough Plate,

Etc., Etc.

**39 ELM STREET,  
BOSTON.**

Wire Cloth

(Manufacturers.)

**DE WITT G. BRO. & CO.**

Belleville Wire Works and Rolling Mills, manufacturers of Paper Makers Materials, Brass, Copper and Iron Wire Cloth Sheet Brass, and Copper Wire, Wire Rope, Wire Cord, Wire Window Shades, 90 John, New York

**ENPIRE WIRE WORKS,**

McMurray & Co. manufacturers of Paper Makers Wires, Laid and Vove Dandy Rolls, Copper, Brass and Iron Wire Cloth, Gangs, Safes, Sieves and Screens. Wire Cloths for Turpentine, Resin, Milk and Sugar Strainers, rice, Corn and Duster Wires. Wire Cloth for Tobacco, Snuff, Brick and Starch manufacturers, Wire Bolting Cloths, and Quartz Machine Wires. 105 Fulton Street, New York. Wire Gauze Window Shades, Garden Wire Works, etc.

**FULTON WIRE WORKS,**

Walter W. Wooley, 51 Fulton street, New York, manufacturer of all kinds of **WIRE CLOTH AND WIRE SHADES**. Wire Cloth for Sugar, Milk and Resin Strainers. Locomotive and **RICE WIRE CLOTH**, Nursery Fenders and Fire Guards, Sieves, Riddles, Coal and Sand Screens, etc. Plain and Ornamental Wire Work

Wire Railing.

**WALKER M. & SONS,**

Wire Railing, Wire Work, etc. 11 N. 6th,  
Philadelphia

Wood and Ivory Turner.

**BYRNES L.**

17 Harvard place, Boston

Wood Engravers.

**LAUDERBACH JAMES W.**

119 S. 4th, Philadelphia

**SMITH FERDINAND,**

110 S. 4th, Philadelphia

**SPITTALL JOHN,**

409 Chestnut, Philadelphia. (See adv't.)

Wood Working Machinery.

**BALL R. & CO.**

Worcester, Mass.

Wooden Ware.

(Manufacturer.)

Howe Oscar F. 31 and 32 S. Market, and 31 and 32  
Chatham, Boston

Woolen Machinery.

**FURBUSH M. A. & SON,**

manufacturers of all kinds of Woolen Machinery, Carding Machines, Roll Carding Machines, Spinning Jacks, Wool Pickers, Cropton Looms, Plain Blanket Looms, Teasing Gigs, Fulling Mills, Harness, Frames, etc. 118 Market, Philadelphia

Gage D. T. 118 Market, Philadelphia  
Hill & Chapman, 60 Pine, New York

**PAINTER DANIEL,**

manufacturer of Woolen Machinery, Carding, Spinning and Weaving, Worcester, Mass.

**TULLY A. C. & CO.**

Woolen Machinery and Woolen Mill Supplies,  
94 Maiden Lane, New York

Yeast Powder.

**PRESTON & MERRILL,**

inventors and manufacturers of Infalible Yeast Powder, Portable Lemonade, Cooking Extracts, etc. Congress, cor. Purchase, Boston

# Oriental Powder Co.,

MANUFACTURERS OF EVERY VARIETY OF

## Sporting Powder,

Which for cleanliness, percussion and penetrating power, is acknowledged by the best Sportsmen in the country, to be unrivalled. The brands are

DIAMOND, 1 lb. Canisters.

FALCON SPORTING, 4 lb. and 6½ lb. Canisters.

WESTERN SPORTING, in kegs, 25, 12, 12½ and 6½ lbs.  
also in 1 lb. Canisters.

## Mining, Blasting & Shipping Powder

Of Superior Quality, and adapted to every requirement of the Trade.

**J. J. NEWHALL, Agent,**

No. 34 River Street,

CHICAGO, ILL.

# WM. D. ROGERS,

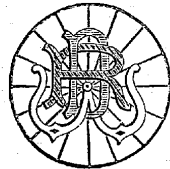

## GARRIAGE BUILDER

Original and Only Manufacturer of the Celebrated

## ROGERS' CARRIAGES,

1009 & 1011 Chestnut Street,

**PHILADELPHIA.**



## J. SPITTALL, ENGRAVER ON WOOD

No. 409 Chestnut St., Philadelphia, Pa.

ALL KINDS OF

BOOK ILLUSTRATIONS, VIEWS OF BUILDINGS, MACHINERY, ETC.

Societies' Seals, Envelope Plates, Illustrations for Printing in Colors,

**BRASS DIES** for **BUSINESS CARDS** and **ENVELOPES,**

**HAND SEAL PRESSES** for **OFFICES** and **SOCIETIES,** &c.

**Union Vise Company**  
OF BOSTON.  
STORE, No. 61 WATER ST., BOSTON, MASS.

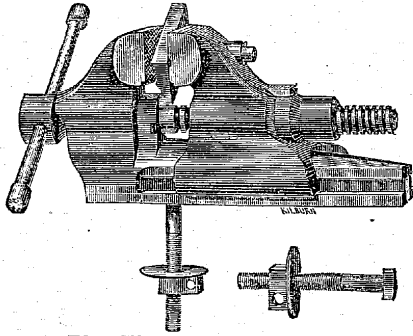
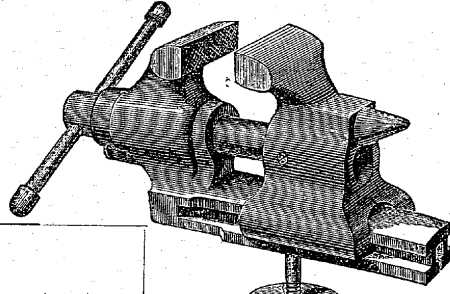
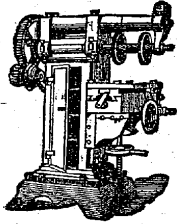

COVERED SCREW.

**FIFTY**

Styles and Sizes

OF

**VISES!**

Constantly on hand and warranted.

**MILLING MACHINES,**

Five Sizes,

Very simple, easily adjusted and of great power  
weighing 2,500, 1,000, 1,050, 1,000 and 900 pounds.

For Sale by the Trade,

**G. H. NOTT, Pres.**  
**A. H. BRAINARD, Supt.**

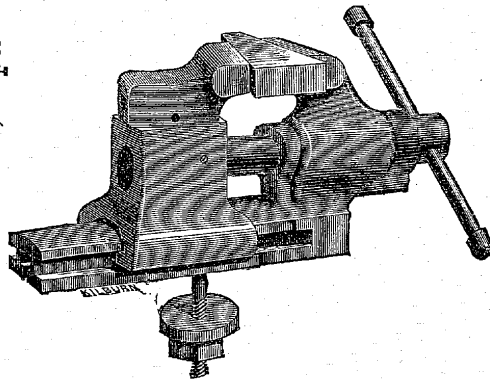

SWIVEL JAW.

**RIEHL'S**  
NEW PATENT SELF-CLAMPING  
**BOOK-CUTTING**  
**MACHINE,**

CLAIMING SUPERIORITY OVER ALL OTHERS

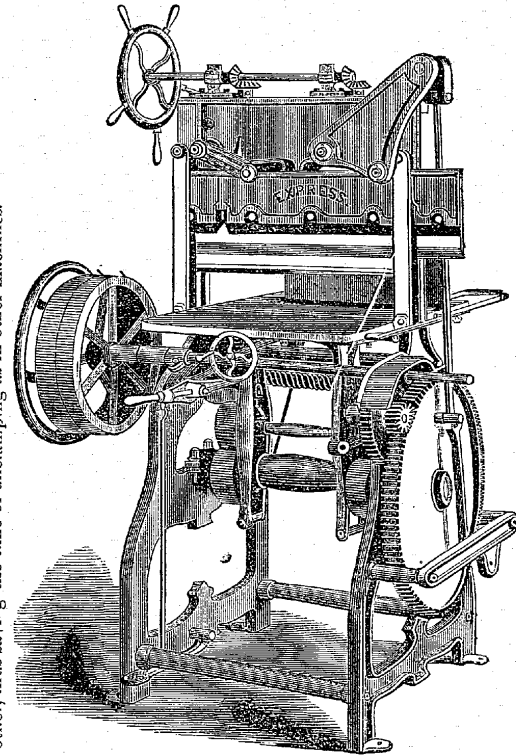

The cut shown represents a Self-Clamping Book Cutting Machine, which I warrant to cut faster and truer than any other Machine in the market. The knife in descending makes a quarter circle motion, and returns with a quick upward motion. As soon as the knife has passed through the books the clamp and bed instantly recede from each other, thus saving the time of unclamping as in other machines.

It has an Index at side of Machine and shows the exact distance in inches and parts of inches between the edge of knife and rear gauge.  
As a Book Cutting Machine it surpasses any cutting machine in the market.  
To cut 24 inches by hand, \$400.00, Power, \$450.00.  
32 " 500.00, " 600.00.  
Other Sizes built to order. Docketing and Gearing extra.

RIEHL'S PATENT—August 28th, 1855. October 2nd, 1866. May 4th, 1869.

**M. RIEHL,**  
MANUFACTURER OF BOOK BINDERS AND PRINTER'S MACHINERY,  
No. 1505 Willow St., Philadelphia, Pa.



# J. F. CURRAN & CO.

MANUFACTURERS AND IMPORTERS OF

## FINE SILVER PLATED WARE

Of every



Description.

18 JOHN STREET.  
NEW YORK.

## BOSTON COPPER WEATHER VANES!

Were awarded the

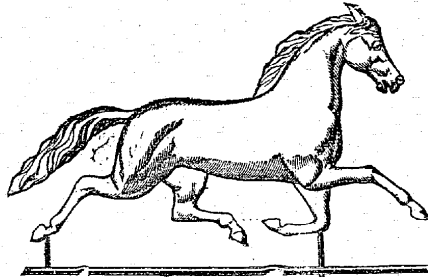

FIRST PREMIUM

At the Great New England and N. H. State Fairs, 1868.

MANUFACTURED BY

**J. HARRIS & SON,**

No. 76 Kingston Street, cor. of Beach,

Opposite the Boston and Albany R. R. Depot, BOSTON, MASS.

The only manufacturers in the United States, of Weather Vanes made entirely of Copper, and gilded with Twenty-three Karet Gold Leaf, designed

**FOR CHURCHES, PUBLIC AND PRIVATE BUILDINGS, FLAG STAFFS, ETC.**

Architects, Contractors, Builders, Dealers and private parties, are respectfully invited to call and examine this the Largest, most Perfect and only assortment of Pure Copper Weather Vanes in America. Orders solicited and promptly attended to. Designs of every description made to order and warranted.

JOSEPHUS HARRIS.  
A. J. HARRIS.

Send for price list.

**J. HARRIS & SON.**

# Refrigerators

Packed and

Short

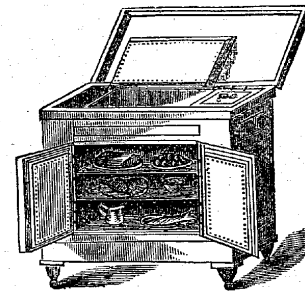

Shipped at

Notice.

**WILLIAM LAW.**

Manufacturer,

709 & 711 Third Avenue, - - NEW YORK.

THOMAS SINCLAIR'S

**Lithographic Establishment**

**Chromo Lithography**

In the FINEST STYLE of ART,

Drawings of every Description.

**506 and 508 North Street,**

**Philadelphia, Pa**

# THE PHILADELPHIA PRINTING INK WORKS.

PHINCIPAL OFFICES:

Tenth and Lombard Sts., Philad'a. | 59Gold St. cor. of Ann, New York.



PHILADELPHIA, Sept, 1st, 1869.  
The undersigned would respectfully announce to Printers and the trade generally, that he has this day associated with him in partnership, under the firm name of

**CHARLES ENEU JOHNSON & CO.**

MR. MARTIN CONNELLY, formerly foreman of Palmer & Co., and for the last two years with Mr. John G. Lightbody, of New York.

CHARLES ENEU JOHNSON.

The undersigned are sole agents for the United States and Canadas of M. CH. LORILLEUX, FILS AINE, PARIS, FRANCE, justly celebrated LITHOGRAPHIC AND TYPOGRAPHIC COLORED INKS AND VARNISHES.

**CHARLES ENEU JOHNSON & CO.**

# THE SUPERIOR Printing Company, Book & Job Printers,

164 South Clark Street,

Constantly employing a large number of first-class practical men in the various departments of Book Making and Job Printing, we offer great inducements to Authors and Persons having Books to publish and Printing to execute.

C. F. WRIGHT, President. G. J. ROBERTS, Sec'y.

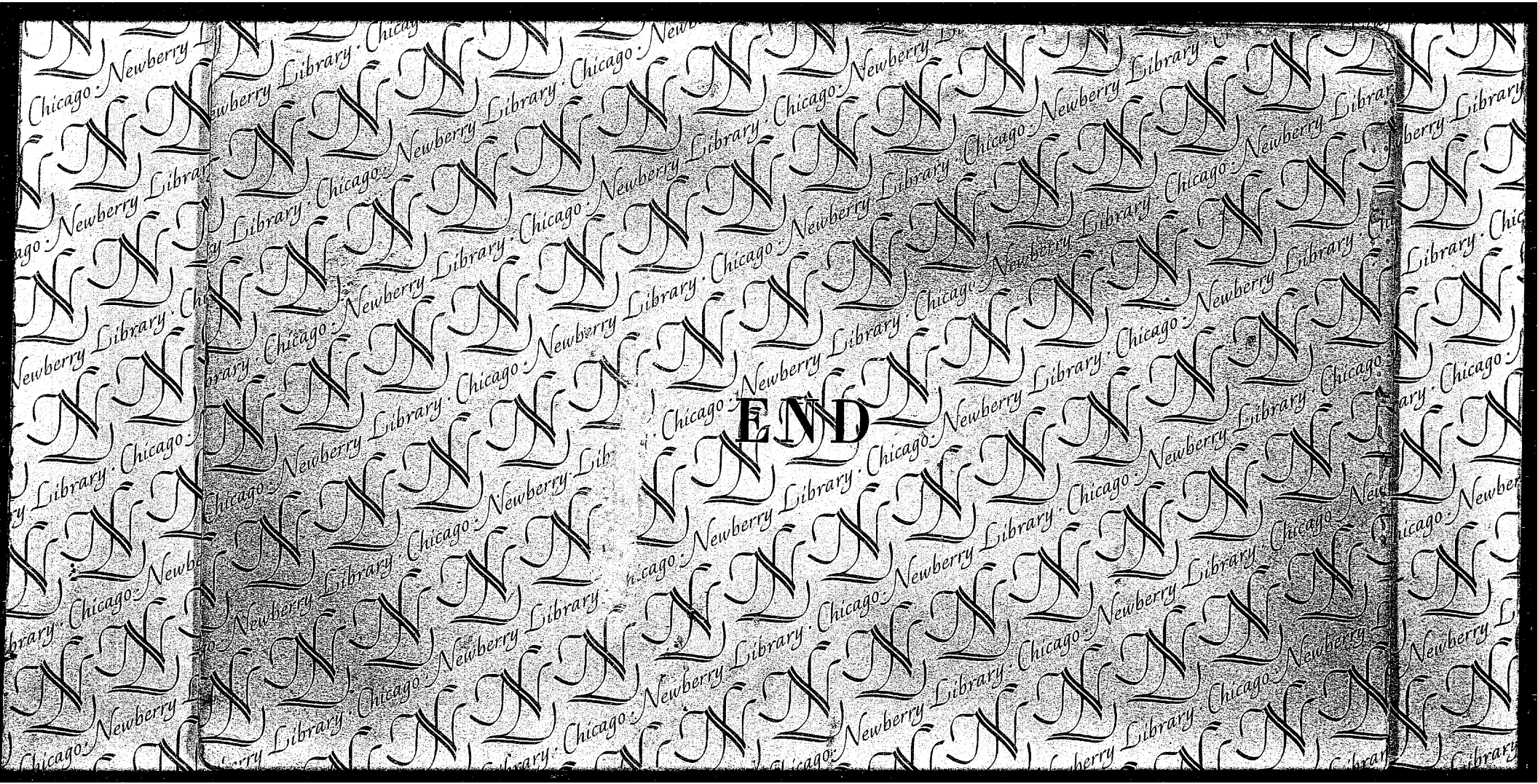

**END**

PHOTODUPLICATION



SERVICE